

12 11 10 9 8 7 6 5 4 3 2 1

H G F E D C B A

[0.067]  
Ø 1.70

[0.228]  
Ø 5.80

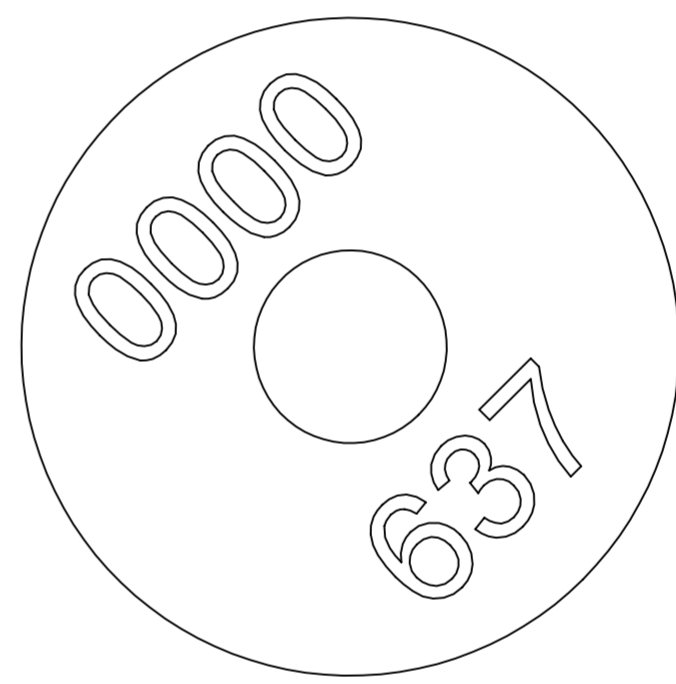
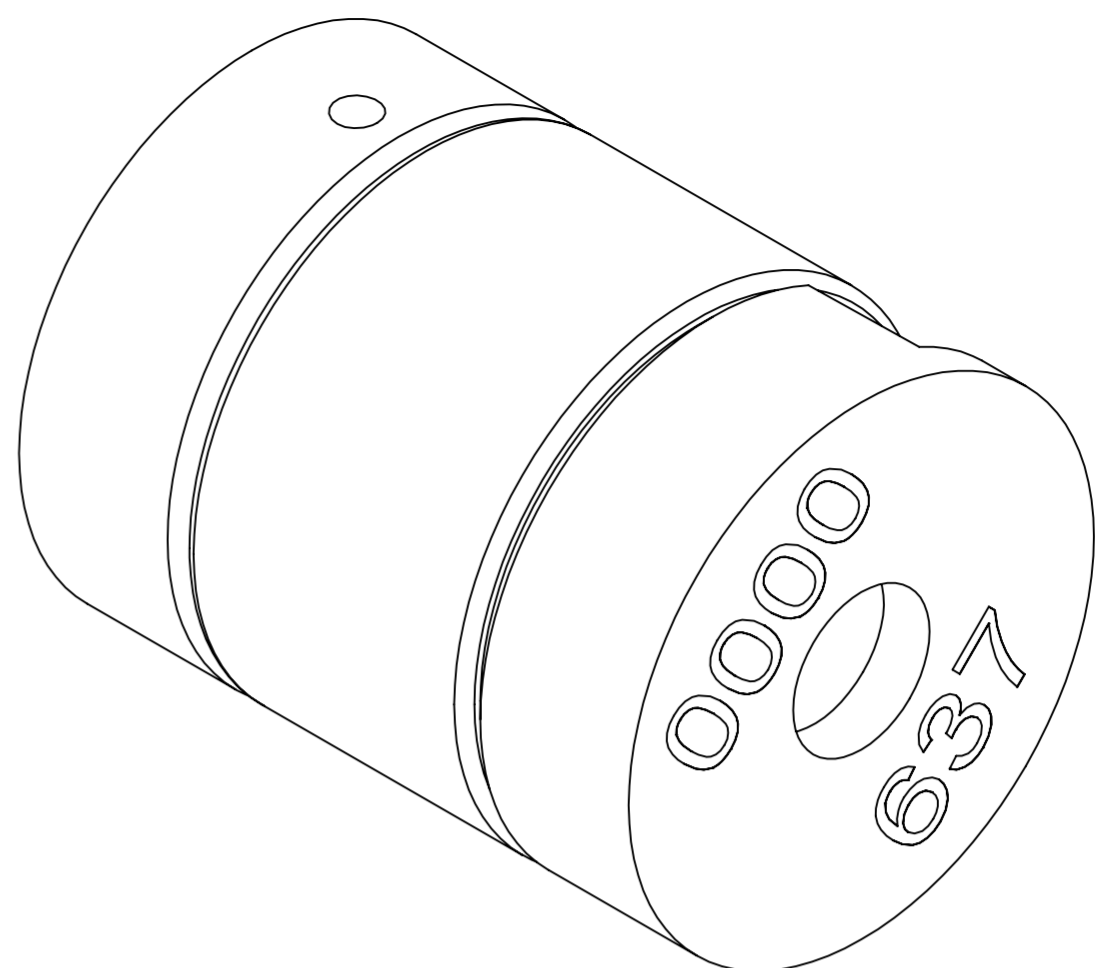
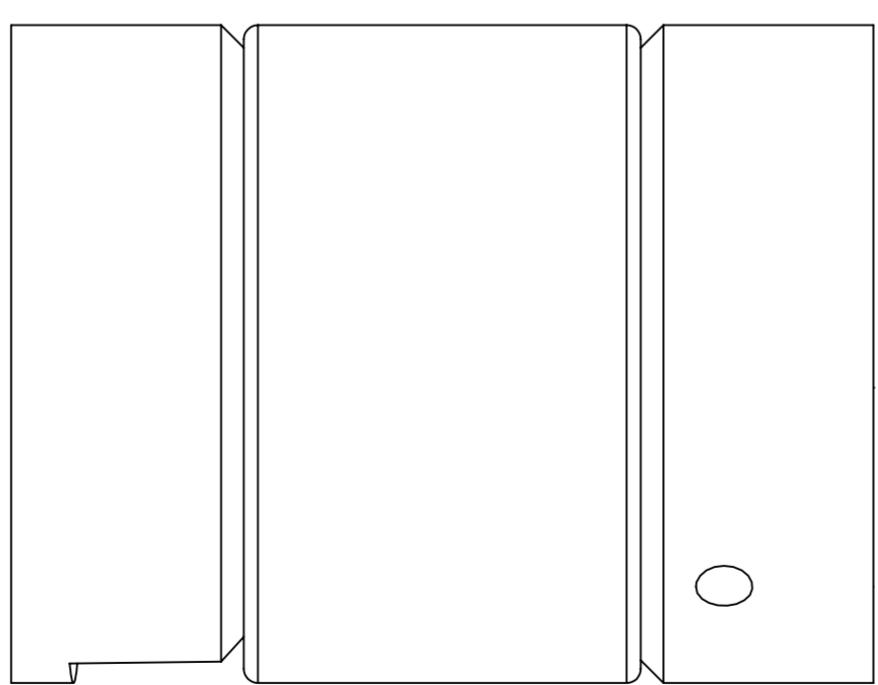
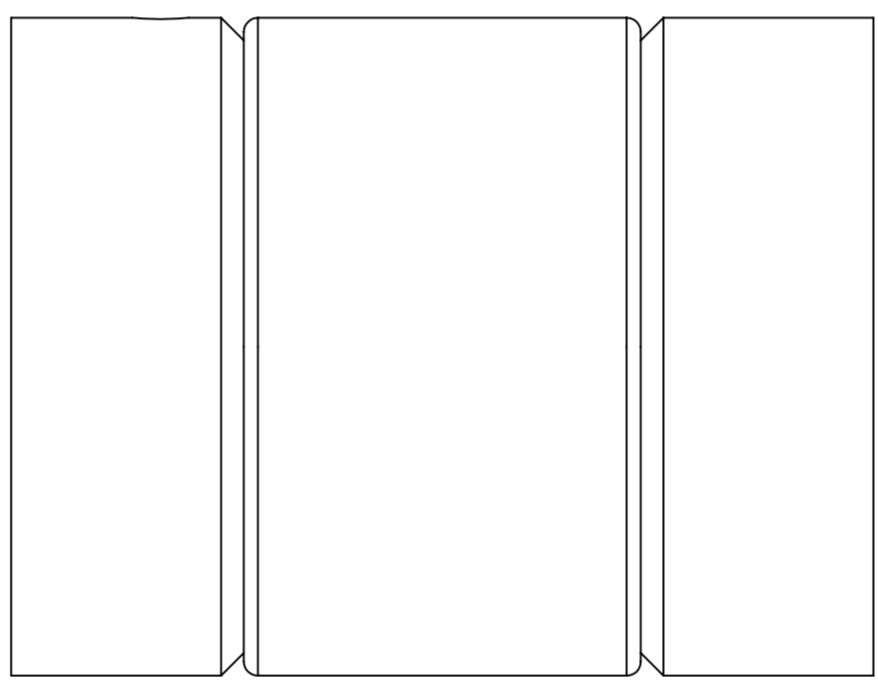
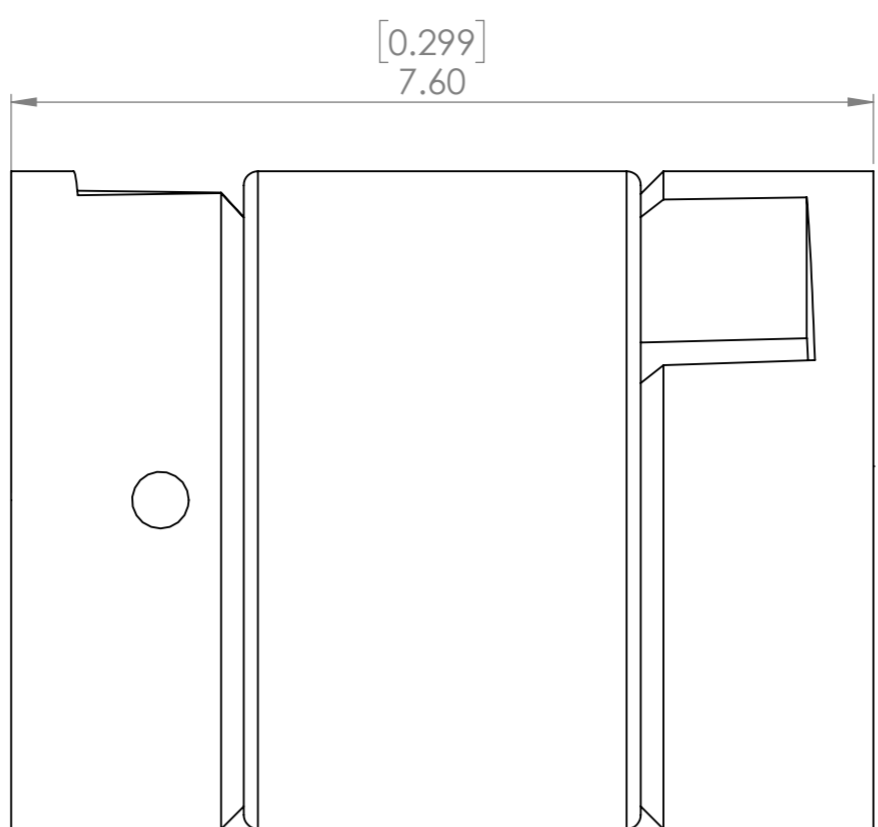
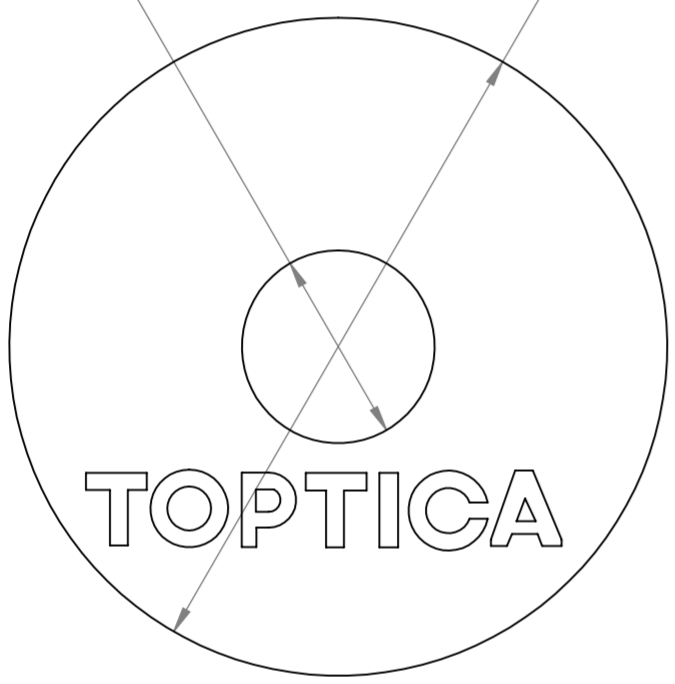

DRAWINGS ARE FOR INFORMATION ONLY,  
NOT INTENDED FOR MANUFACTURING PURPOSES

DIMENSIONS ARE IN MILLIMETERS  
[ XXX ] ARE IN INCHES  
SUBJECT TO CHANGE WITHOUT NOTICE

METRIC DRAWINGS

TOPTICA  
Photonics, Inc. 1120 Pittsford Victor Rd  
Pittsford, NY 14534

TITLE: 637nm SINGLE STAGE  
MINI ISOLATOR

THIRD ANGLE PROJECTION

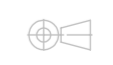

EXCEPT AS MAY BE OTHERWISE PROVIDED BY  
CONTRACT, THESE DRAWINGS AND SPECIFICATIONS  
ARE THE PROPERTY OF TOPTICA PHOTONICS, INC.  
AND ARE ISSUED IN STRICT CONFIDENCE, AND SHALL  
NOT BE REPRODUCED, OR COPIED, OR USED AS THE  
BASIS FOR THE MANUFACTURE OR SALE OF  
APPARATUS WITHOUT PERMISSION.

DWG NO. M\_SSR 637\_EXTERNAL REV A

SIZE A2 SCALE: 1:1 SHEET 1 OF 1

12 11 10 9 8 7 6 5 4 3 2 1