

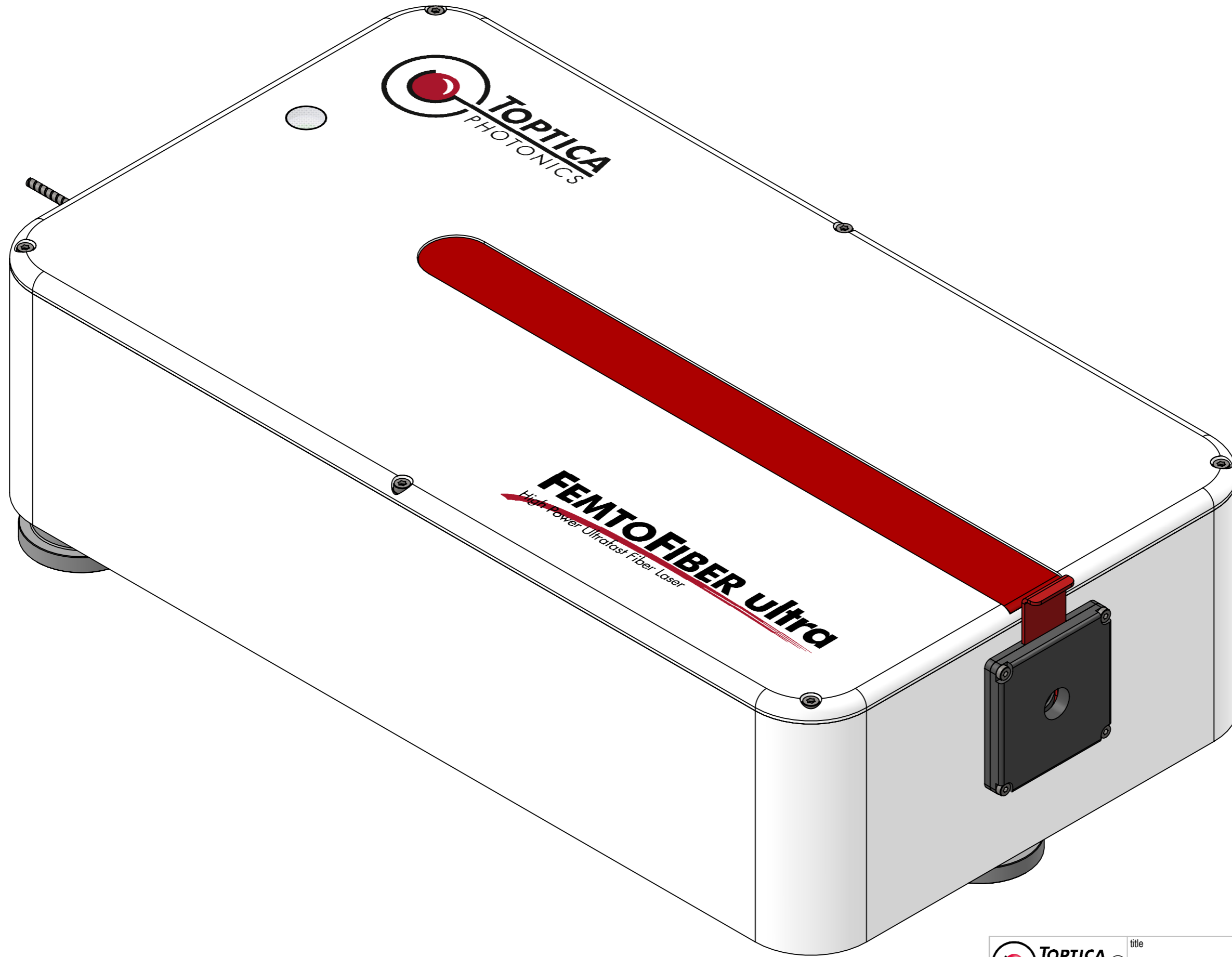



NOTE: This document is property of the company TOPTICA Photonics AG. All copyrights, trademarks, patents and other rights in connection herewith are expressly reserved to the company TOPTICA Photonics AG and no license is created hereby.



 TOPTICA Photonics AG Tel.: 089-85837-0 Lochhamer Schlag 19 Fax.: 089-85837-200 82166 Grafelfing Web: www.toptica.com	title	scale		
	FemtoFiber ultra 920	1:1		
dimensions are in mm	general tolerance	projection	date	sheet
view 3D	DIN ISO 2768 - mK		15.03.2019	1/7

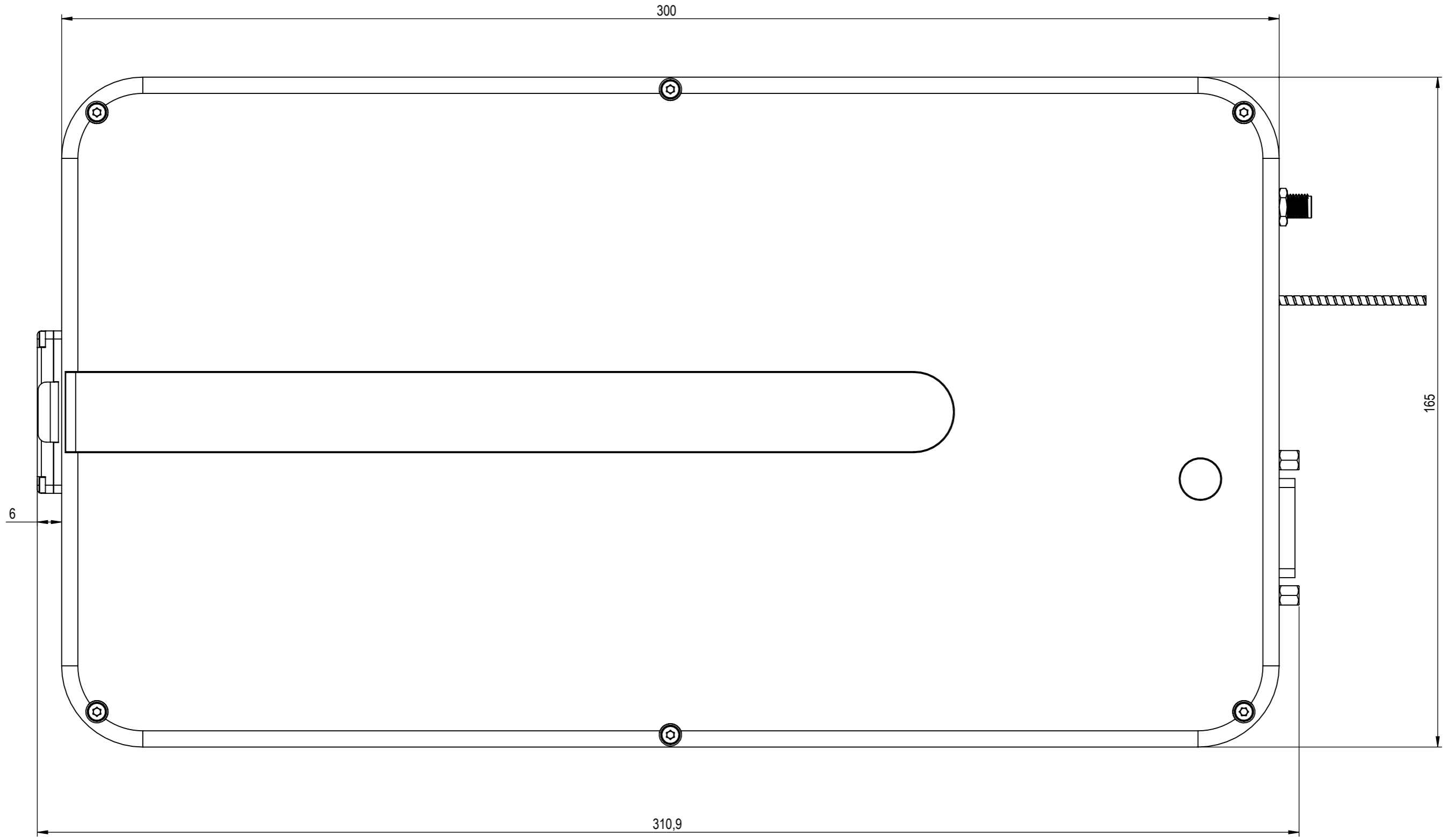

NOTE: This document is property of the company TOPTICA Photonics AG. All copyrights, trademarks, patents and other rights in connection herewith are expressly reserved to the company TOPTICA Photonics AG and no license is created hereby.



 <small>TOPTICA Photonics AG Tel.: 089-85837-0 Lochhamer Schlag 19 Fax: 089-85837-200 82166 Grafelfing Web: www.toptica.com</small>	title	scale
	FemtoFiber ultra 920	1:1
dimensions are in mm	general tolerance	projection
view TOP	DIN ISO 2768 - mK	15.03.2019
	date	sheet
	15.03.2019	2/7

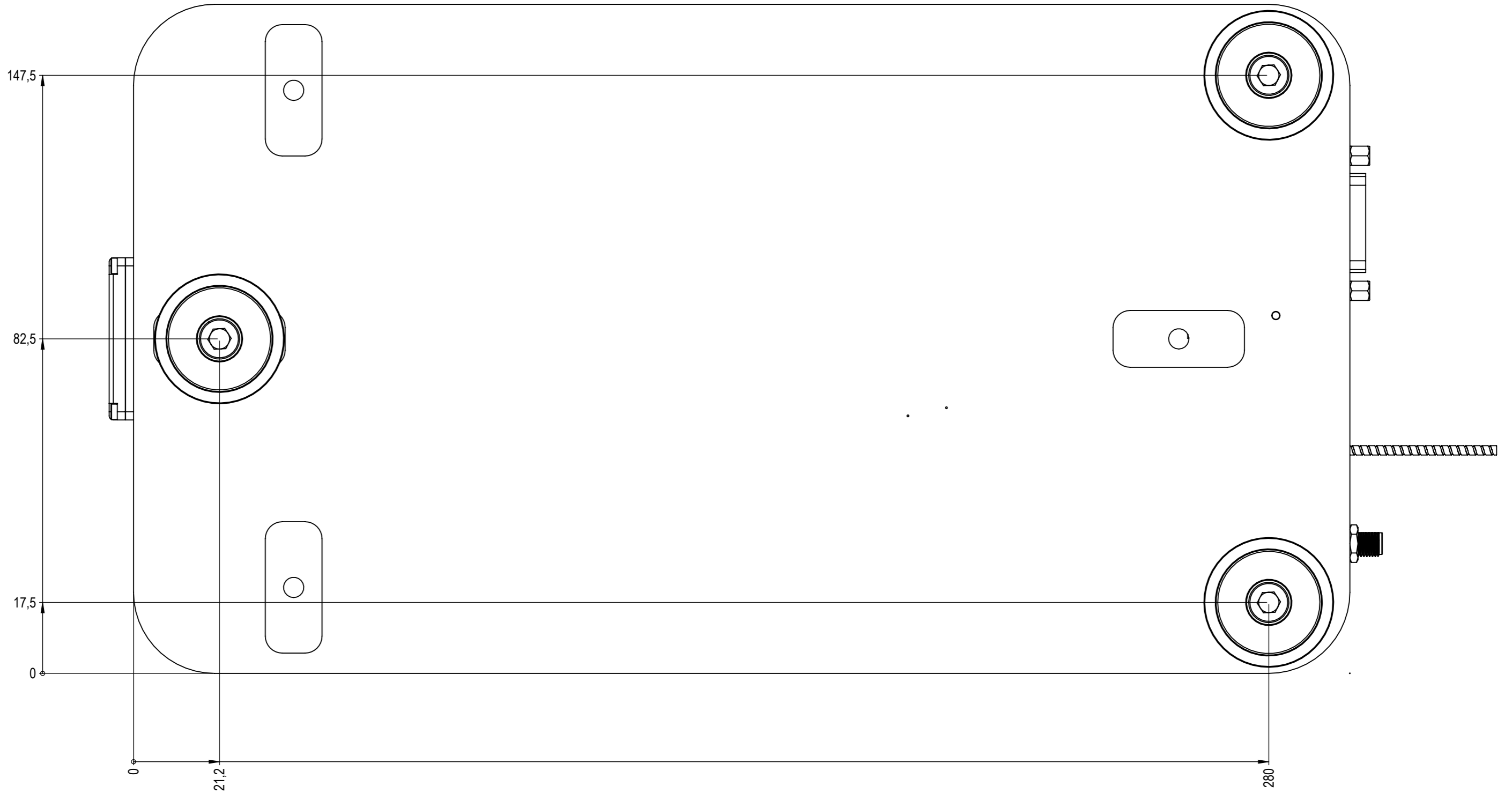

NOTE: This document is property of the company TOPTICA Photonics AG. All copyrights, trademarks, patents and other rights in connection herewith are expressly reserved to the company TOPTICA Photonics AG and no license is created hereby.

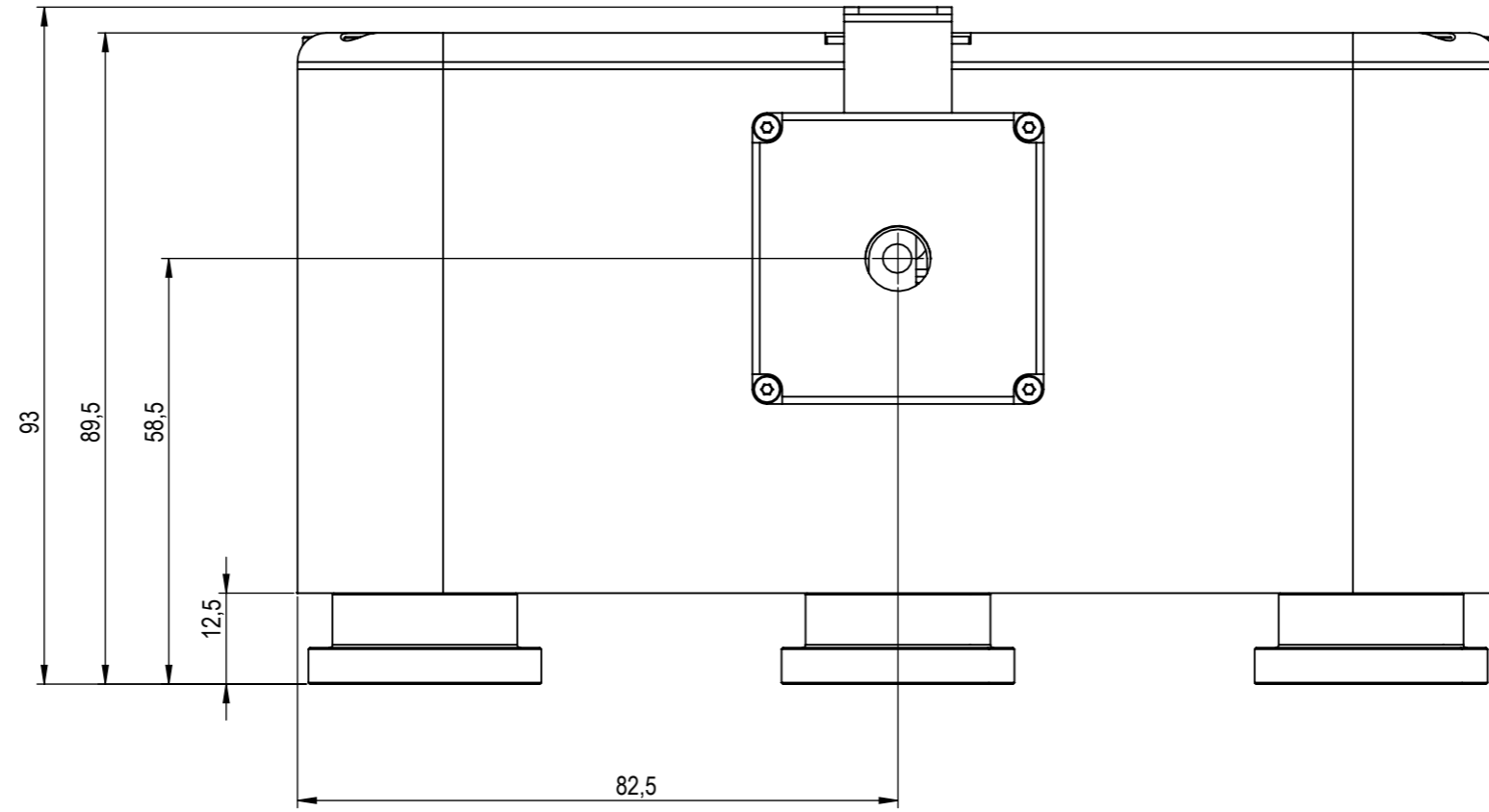

 <small>TOPTICA Photonics AG Tel.: 089-85837-0 Lochamer Schlag 19 Fax: 089-85837-200 82166 Gräfelfing Web: www.toptica.com</small>	title	scale
	FemtoFiber ultra 920	1:1
dimensions are in mm	general tolerance	projection
view BOTTOM	DIN ISO 2768 - mK	
	date	sheet
	15.03.2019	3/7

NOTE: This document is property of the company TOPTICA Photonics AG. All copyrights, trademarks, patents and other rights in connection herewith are expressly reserved to the company TOPTICA Photonics AG and no license is created hereby.



 <small>TOPTICA Photonics AG Tel.: 089-85837-0 Lochhamer Schlag 19 Fax: 089-85837-200 82166 Grafelfing Web: www.toptica.com</small>	title	scale
	FemtoFiber ultra 920	1:1
dimensions are in mm	general tolerance	projection
view FRONT	DIN ISO 2768 - mK	
	date	sheet
	15.03.2019	4/7

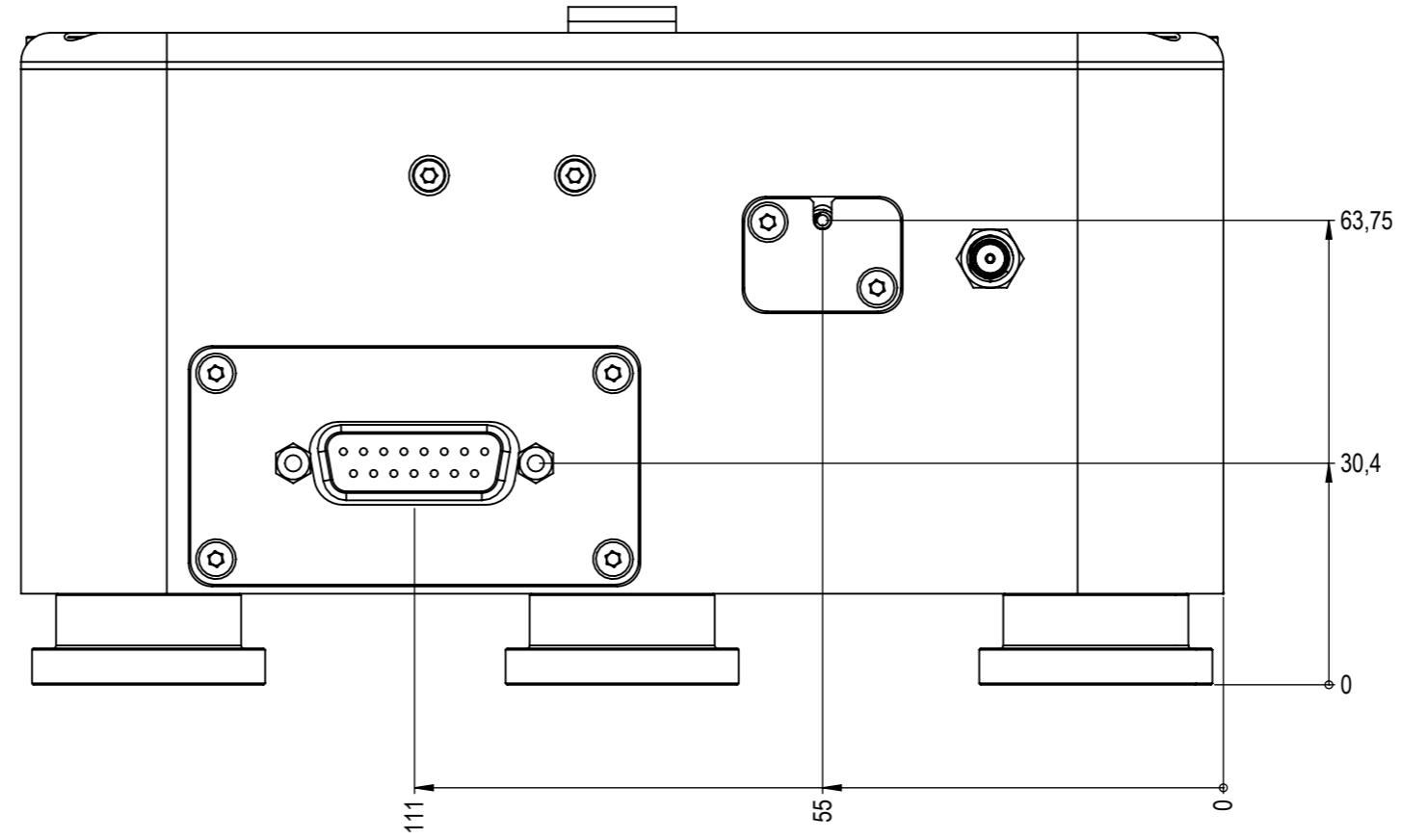

NOTE: This document is property of the company TOPTICA Photonics AG. All copyrights, trademarks, patents and other rights in connection herewith are expressly reserved to the company TOPTICA Photonics AG and no license is created hereby.



 <small>TOPTICA Photonics AG Tel.: 089-85837-0 Lochhamer Schlag 19 Fax.: 089-85837-200 82166 Gräfelfing Web: www.toptica.com</small>	title	scale
	FemtoFiber ultra 920	1:1
dimensions are in mm	general tolerance	projection
view BACK	DIN ISO 2768 - mK	15.03.2019
	date	sheet
	5/7	

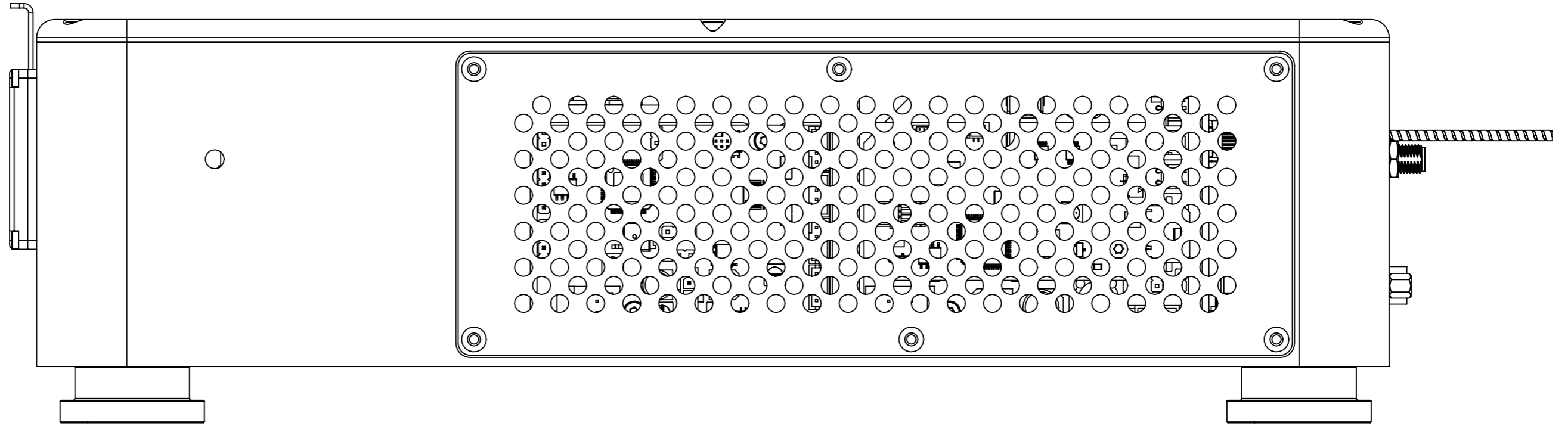

NOTE: This document is property of the company TOPTICA Photonics AG. All copyrights, trademarks, patents and other rights in connection herewith are expressly reserved to the company TOPTICA Photonics AG and no license is created hereby.

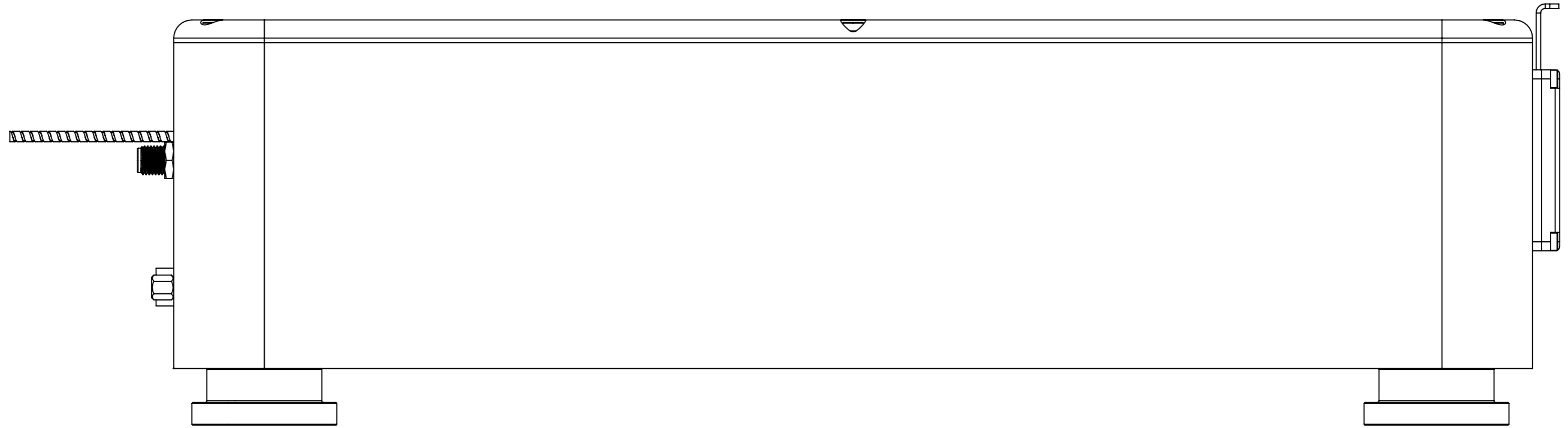

 <small>TOPTICA Photonics AG Tel.: 089-85837-0 Lochhamer Schlag 19 Fax.: 089-85837-200 82166 Grafelfing Web: www.toptica.com</small>	title		scale
	FemtoFiber ultra 920		1:1
dimensions are in mm	general tolerance	projection	sheet
view RIGHT	DIN ISO 2768 - mK	 15.03.2019	6/7

NOTE: This document is property of the company TOPTICA Photonics AG. All copyrights, trademarks, patents and other rights in connection herewith are expressly reserved to the company TOPTICA Photonics AG and no license is created hereby.



 TOPTICA Photonics AG Tel.: 089-85837-0 Lochhamer Schlag 19 Fax.: 089-85837-200 82166 Grafelfing Web: www.toptica.com	title	scale		
	FemtoFiber ultra 920	1:1		
dimensions are in mm	general tolerance	projection	date	sheet
view LEFT	DIN ISO 2768 - mK		15.03.2019	7/7