

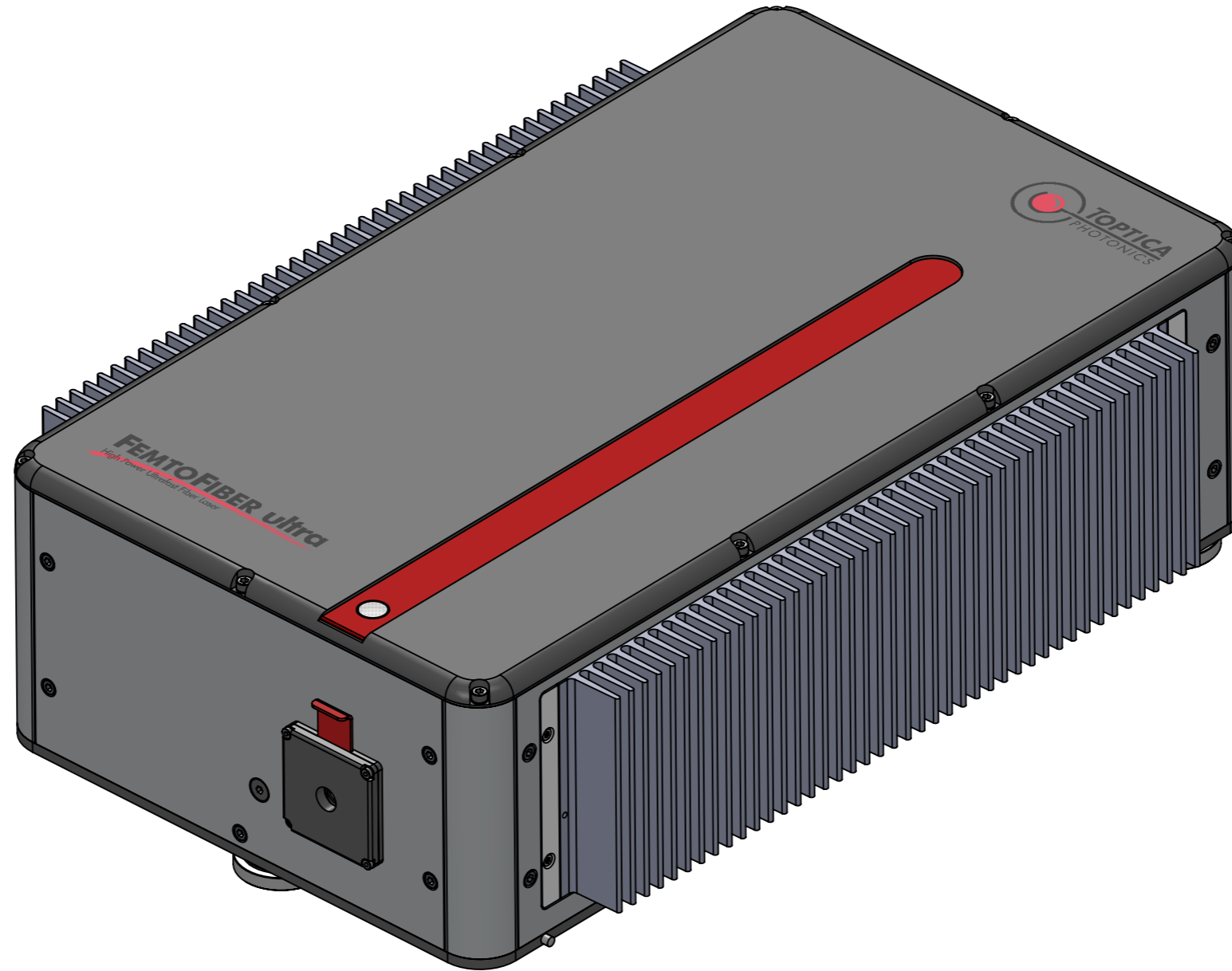



NOTE: This document is property of the company TOPTICA Photonics AG. All copyrights, trademarks, patents and other rights in connection herewith are expressly reserved to the company TOPTICA Photonics AG and no license is created hereby.

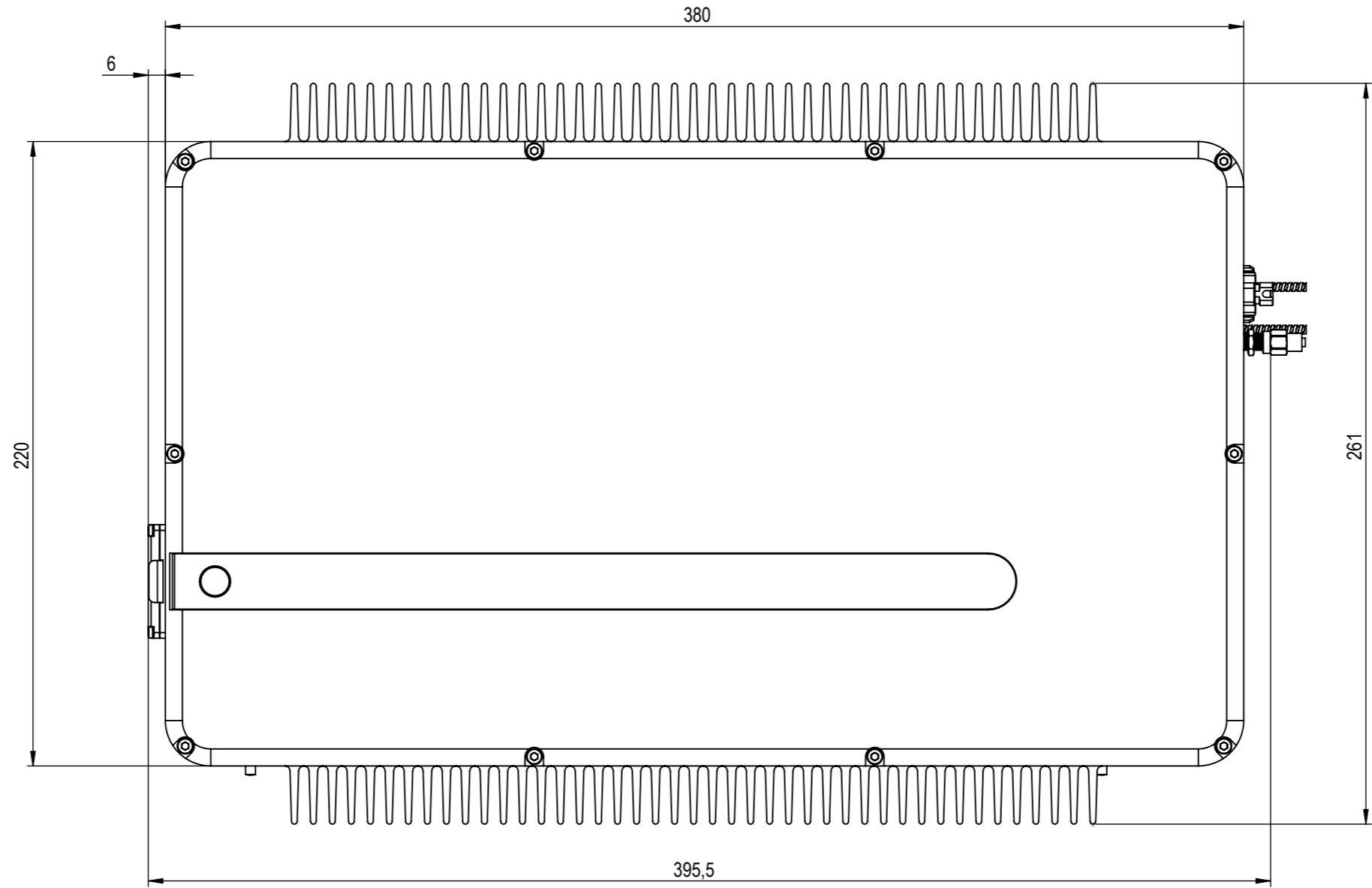

 Lochhamer Schlag 19 82166 Gräfelfing Tel.: 089-85837-0 Fax.: 089-85837-200	title		scale
	FemtoFiber ultra		1:5
dimensions are in mm	general tolerance	projection	format
view 3D	DIN ISO 2768 - mK		A3
		date	sheet
		16.11.16	1/7

NOTE: This document is property of the company TOPTICA Photonics AG. All copyrights, trademarks, patents and other rights in connection herewith are expressly reserved to the company TOPTICA Photonics AG and no license is created hereby.



 Lochhamer Schlag 19 82166 Grafelfing Tel.: 089-85837-0 Fax.: 089-85837-200	title		scale
	FemtoFiber ultra		1:5
dimensions are in mm	general tolerance	projection	sheet
view TOP	DIN ISO 2768 - mK		2/7
		date	
		16.11.16	

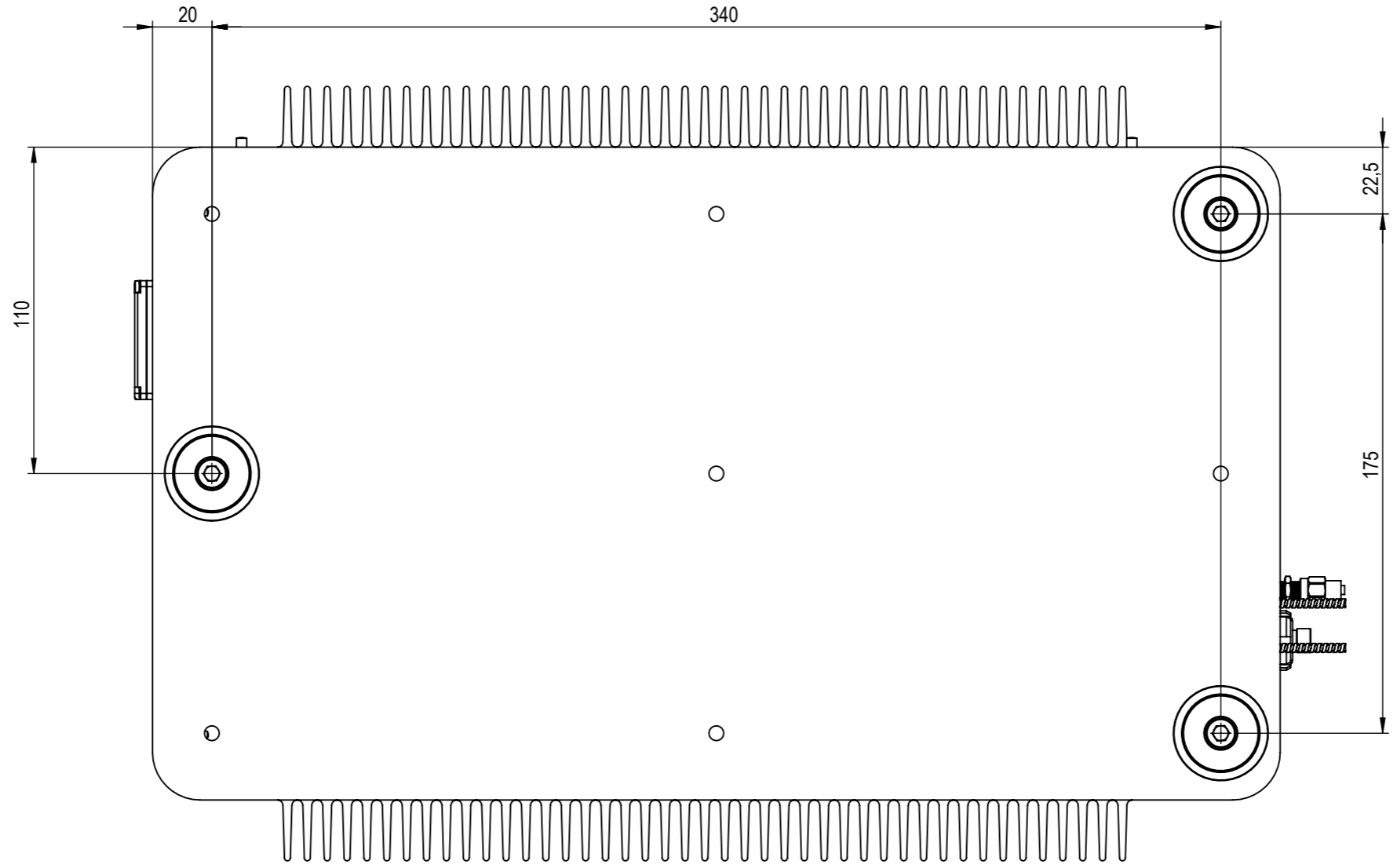

NOTE: This document is property of the company TOPTICA Photonics AG. All copyrights, trademarks, patents and other rights in connection herewith are expressly reserved to the company TOPTICA Photonics AG and no license is created hereby.

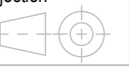

 Lochhamer Schlag 19 82166 Gräfelfing Tel.: 089-85837-0 Fax.: 089-85837-200	title		scale
	FemtoFiber ultra		1:5
dimensions are in mm	general tolerance	projection	format
view BOTTOM	DIN ISO 2768 - mK		A3
		date	sheet
		16.11.16	3/7

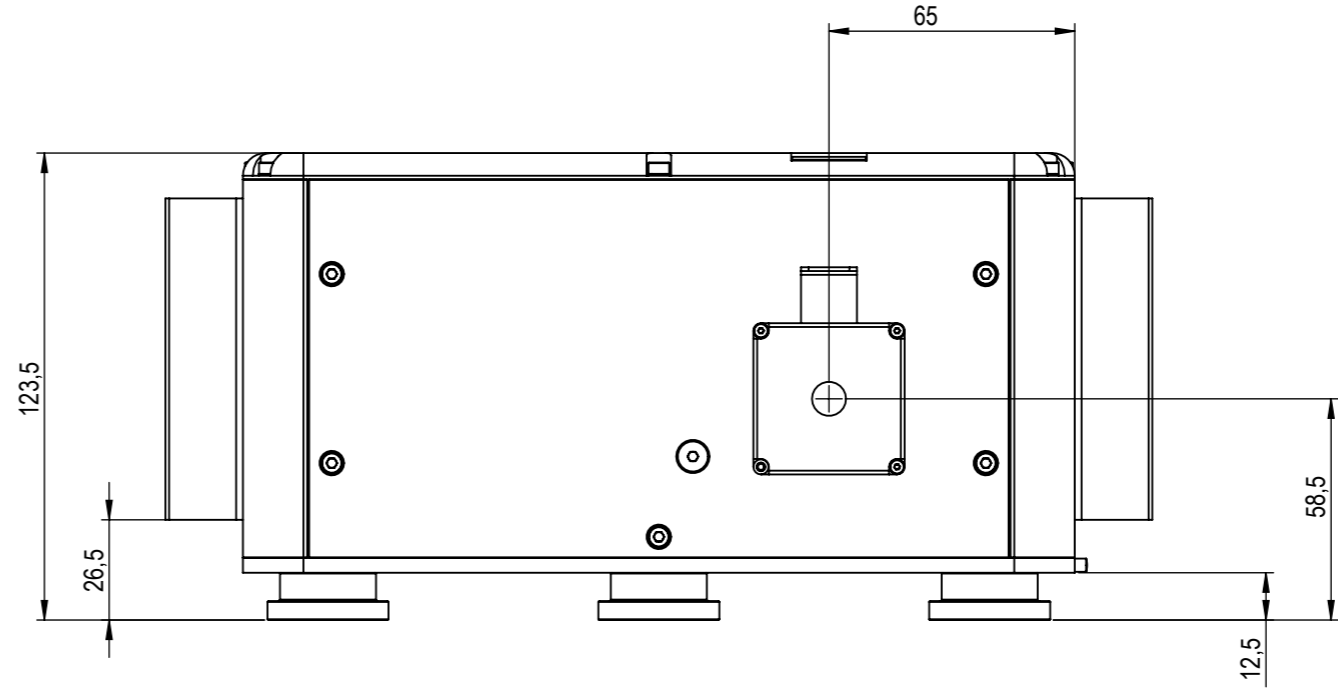

NOTE: This document is property of the company TOPTICA Photonics AG. All copyrights, trademarks, patents and other rights in connection herewith are expressly reserved to the company TOPTICA Photonics AG and no license is created hereby.



 Lochhamer Schlag 19 82166 Gräfelfing Tel.: 089-85837-0 Fax.: 089-85837-200	title		scale
	FemtoFiber ultra		1:5
dimensions are in mm	general tolerance	projection	sheet
view FRONT	DIN ISO 2768 - mK		4/7
		date	
		16.11.16	

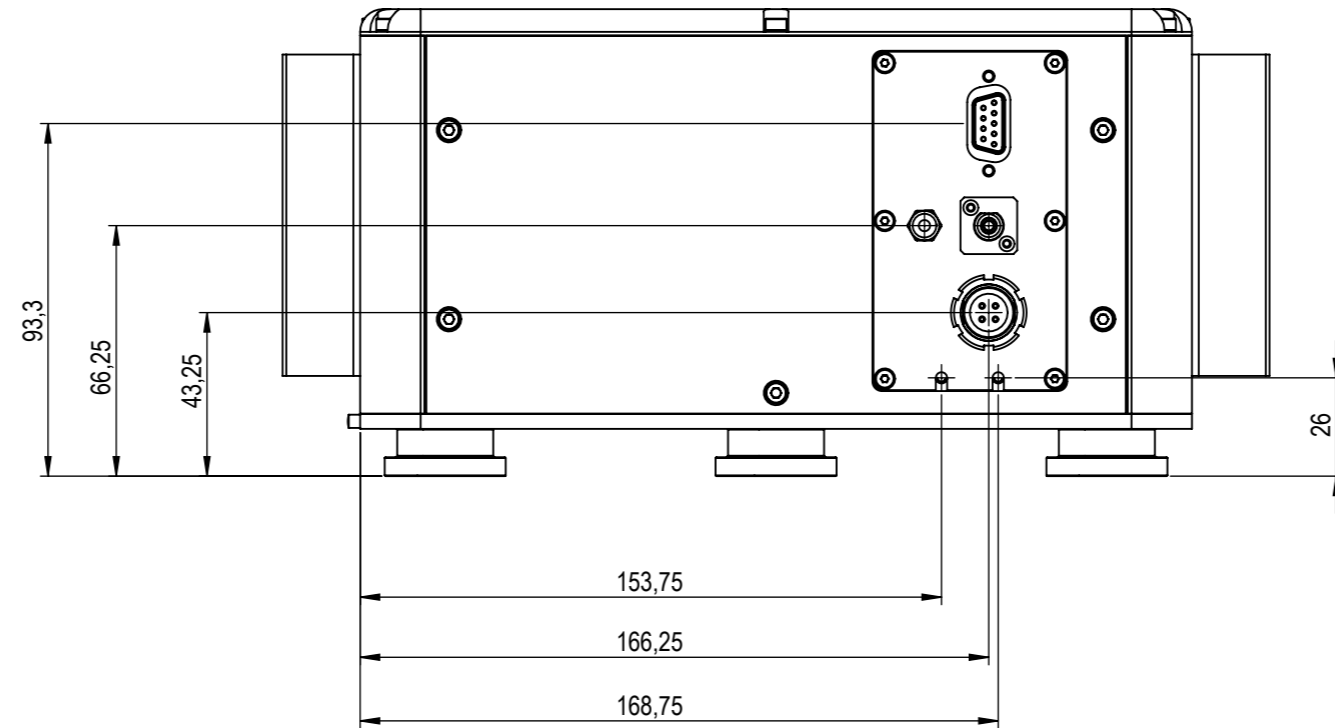

NOTE: This document is property of the company TOPTICA Photonics AG. All copyrights, trademarks, patents and other rights in connection herewith are expressly reserved to the company TOPTICA Photonics AG and no license is created hereby.



 Lochhamer Schlag 19 82166 Gräfelfing Tel.: 089-85837-0 Fax.: 089-85837-200	title		scale
	FemtoFiber ultra		1:5
dimensions are in mm	general tolerance	projection	date
view BACK	DIN ISO 2768 - mK		16.11.16
			sheet
			5/7

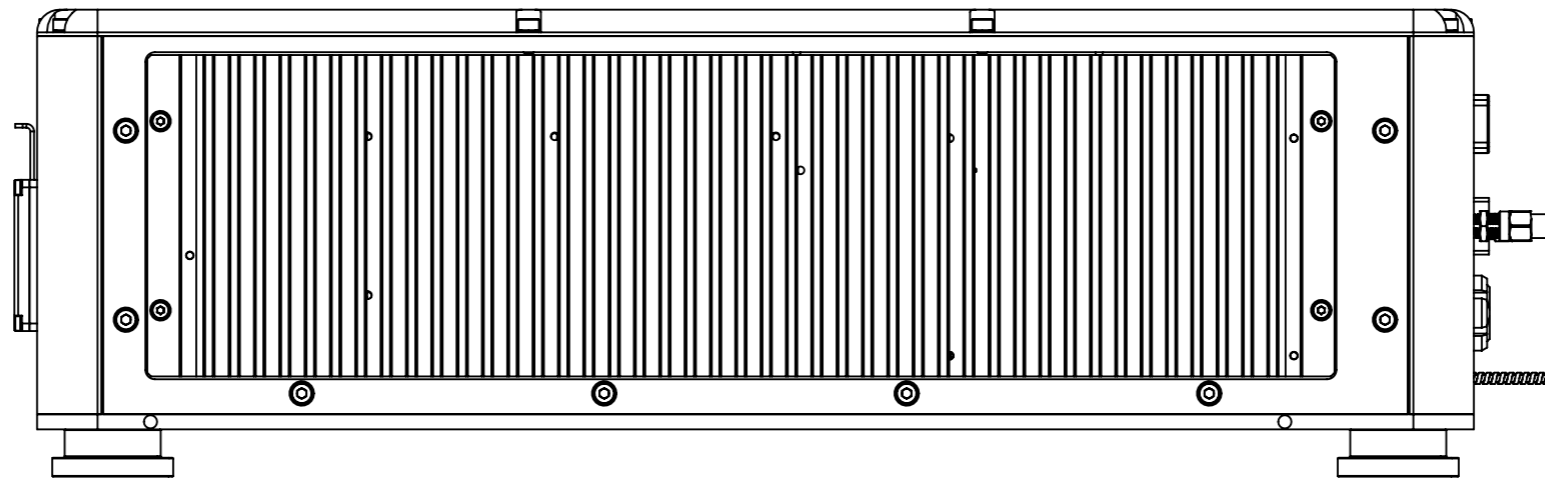

NOTE: This document is property of the company TOPTICA Photonics AG. All copyrights, trademarks, patents and other rights in connection herewith are expressly reserved to the company TOPTICA Photonics AG and no license is created hereby.

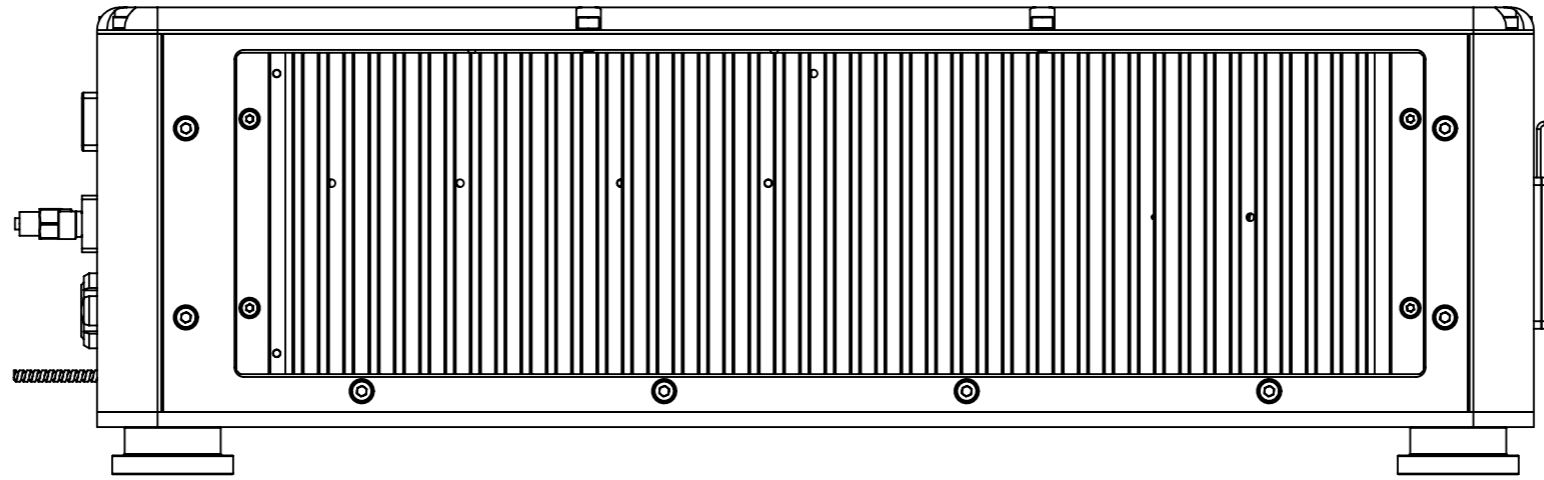

 Lochhamer Schlag 19 82166 Grafelfing Tel.: 089-85837-0 Fax.: 089-85837-200	title		scale
	FemtoFiber ultra		1:5
dimensions are in mm	general tolerance	projection	date
view RECHT	DIN ISO 2768 - mK		16.11.16
			sheet
			6/7

NOTE: This document is property of the company TOPTICA Photonics AG. All copyrights, trademarks, patents and other rights in connection herewith are expressly reserved to the company TOPTICA Photonics AG and no license is created hereby.



 Lochamer Schlag 19 82166 Gräfelfing Tel.: 089-85837-0 Fax.: 089-85837-200	title	scale		
	FemtoFiber ultra	1:5		
dimensions are in mm	general tolerance	projection	date	sheet
view LINKS	DIN ISO 2768 - mK		16.11.16	7/7