

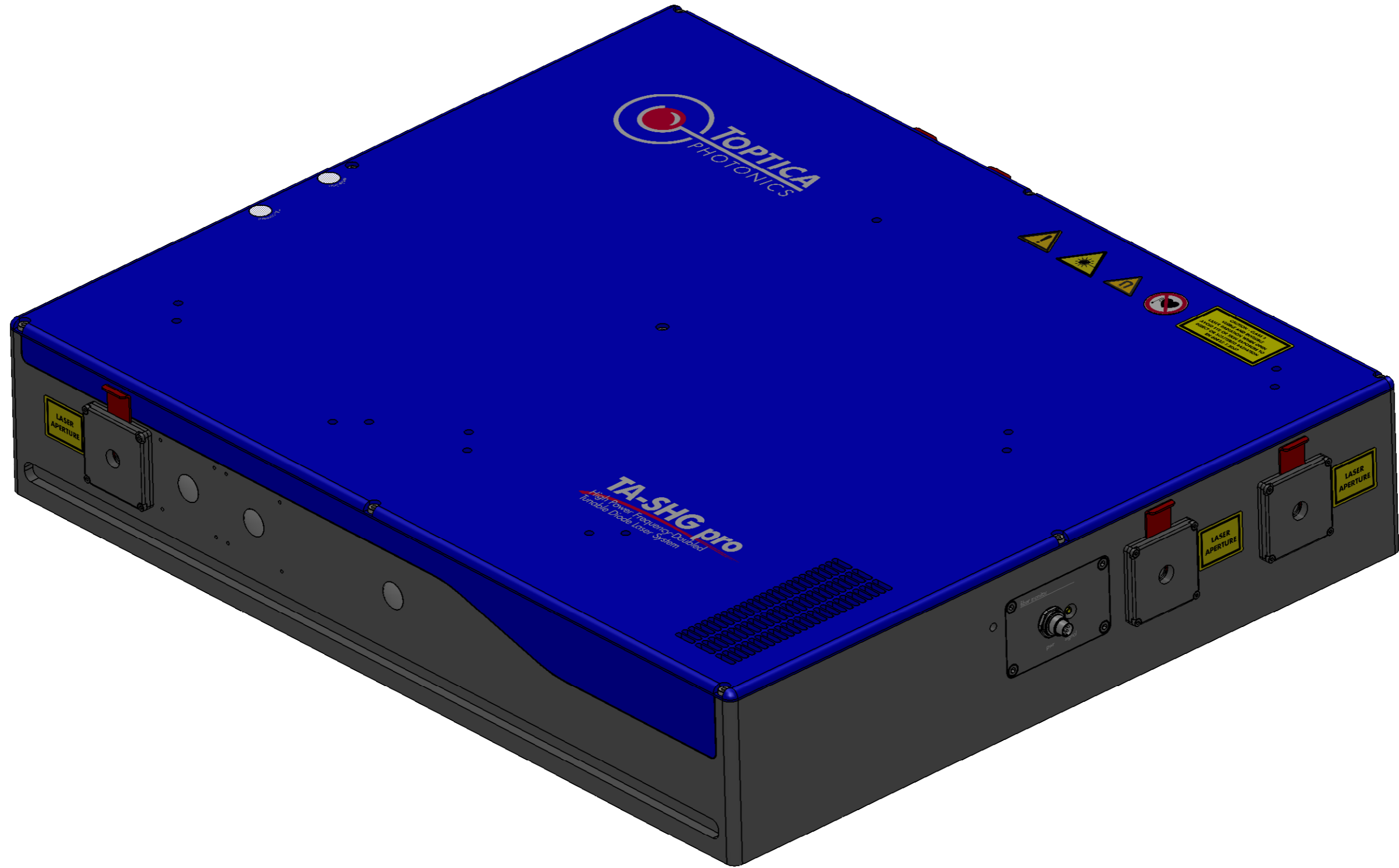



NOTE: This document is property of the company TOPTICA Photonics AG. All copyrights, trademarks, patents and other rights in connection herewith are expressly reserved to the company TOPTICA Photonics AG and no license is created hereby.



 TOPTICA PHOTONICS Lochhamer Schlag 19 82166 Gräfelfing Tel.: 089-85837-0 Fax.: 089-85837-200	title		scale
	TA-SHG pro		1:2
dimensions are in mm	general tolerance	projection	sheet
view 3D	DIN ISO 2768 - mK		1/7
		date	
		06.03.2015	

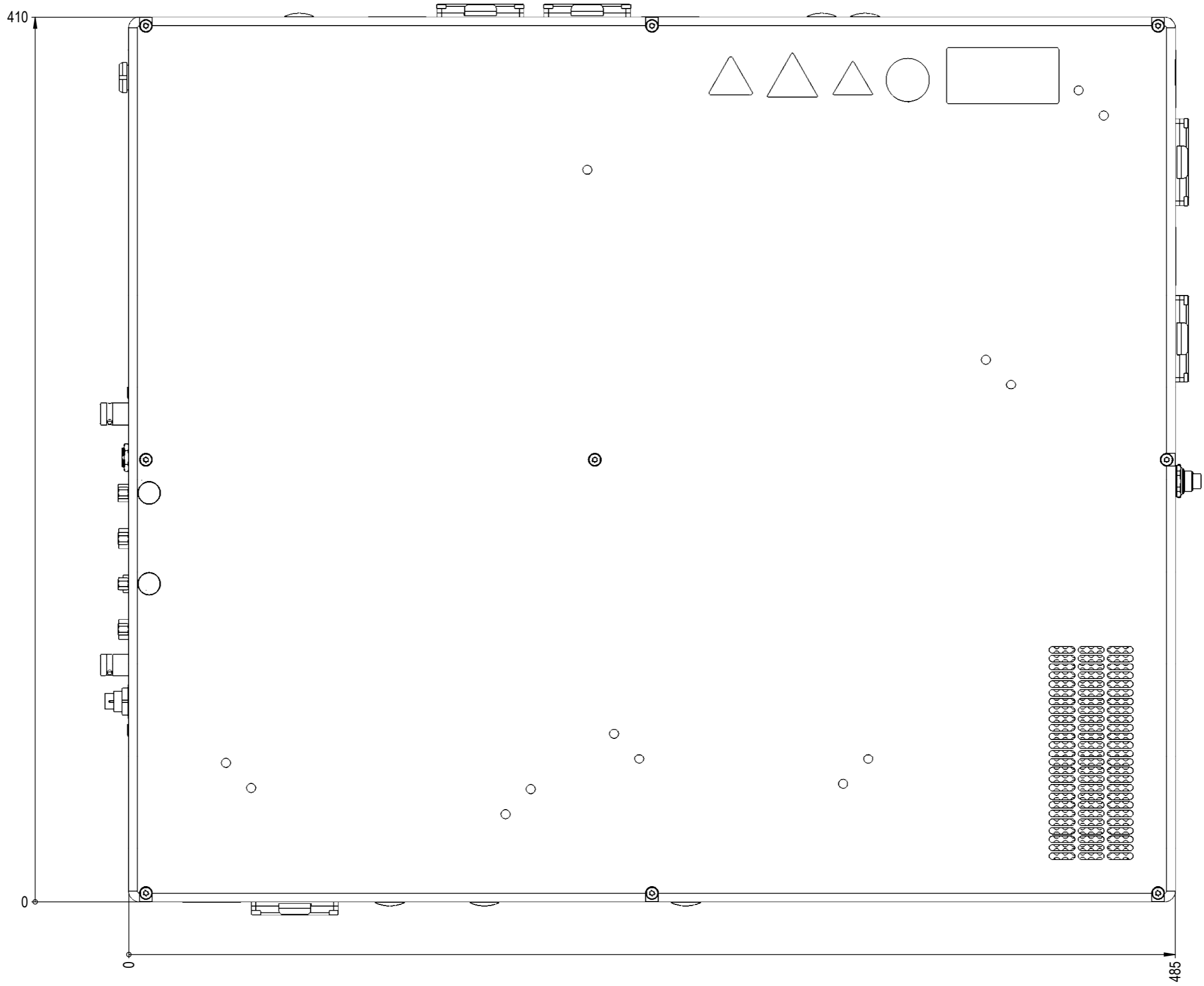

NOTE: This document is property of the company TOPTICA Photonics AG. All copyrights, trademarks, patents and other rights in connection herewith are expressly reserved to the company TOPTICA Photonics AG and no license is created hereby.



 Lochhamer Schlag 19 82166 Gräfelfing Tel.: 089-85837-0 Fax.: 089-85837-200	title	scale
	TA-SHG pro	1:2
dimensions are in mm	general tolerance	projection
view TOP	DIN ISO 2768 - mK	
	date	sheet
	06.03.2015	2/7

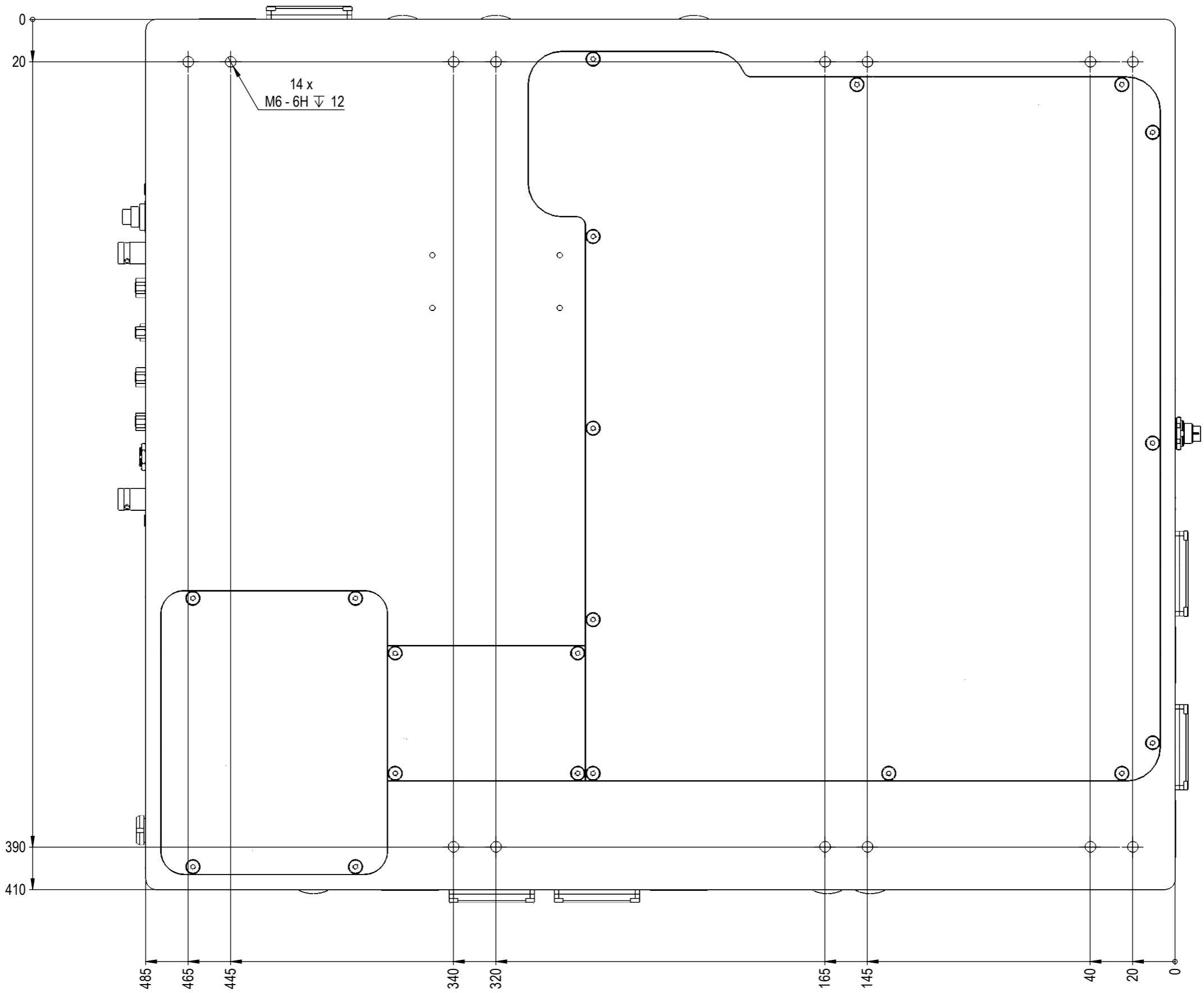

NOTE: This document is property of the company TOPTICA Photonics AG. All copyrights, trademarks, patents and other rights in connection herewith are expressly reserved to the company TOPTICA Photonics AG and no license is created hereby.



 Lochhamer Schlag 19 82166 Gräfelfing Tel.: 089-85837-0 Fax.: 089-85837-200	title	scale
	TA-SHG pro	1:2
dimensions are in mm	general tolerance	projection
view BOTTOM	DIN ISO 2768 - mK	
	date	sheet
	06.03.2015	3/7

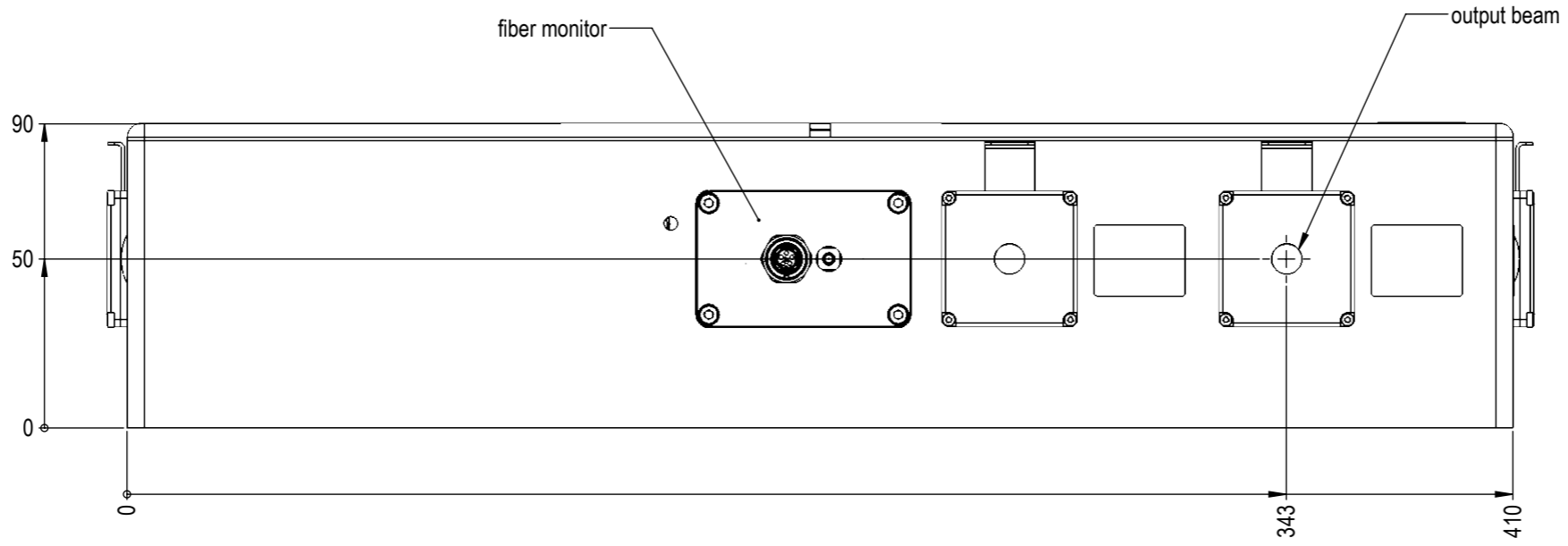

NOTE: This document is property of the company TOPTICA Photonics AG. All copyrights, trademarks, patents and other rights in connection herewith are expressly reserved to the company TOPTICA Photonics AG and no license is created hereby.



 Lochhamer Schlag 19 82166 Grafelfing Tel.: 089-85837-0 Fax.: 089-85837-200	title		scale
	TA-SHG pro		1:2
dimensions are in mm	general tolerance	projection	sheet
view FRONT	DIN ISO 2768 - mK		4/7
		date	
		06.03.2015	

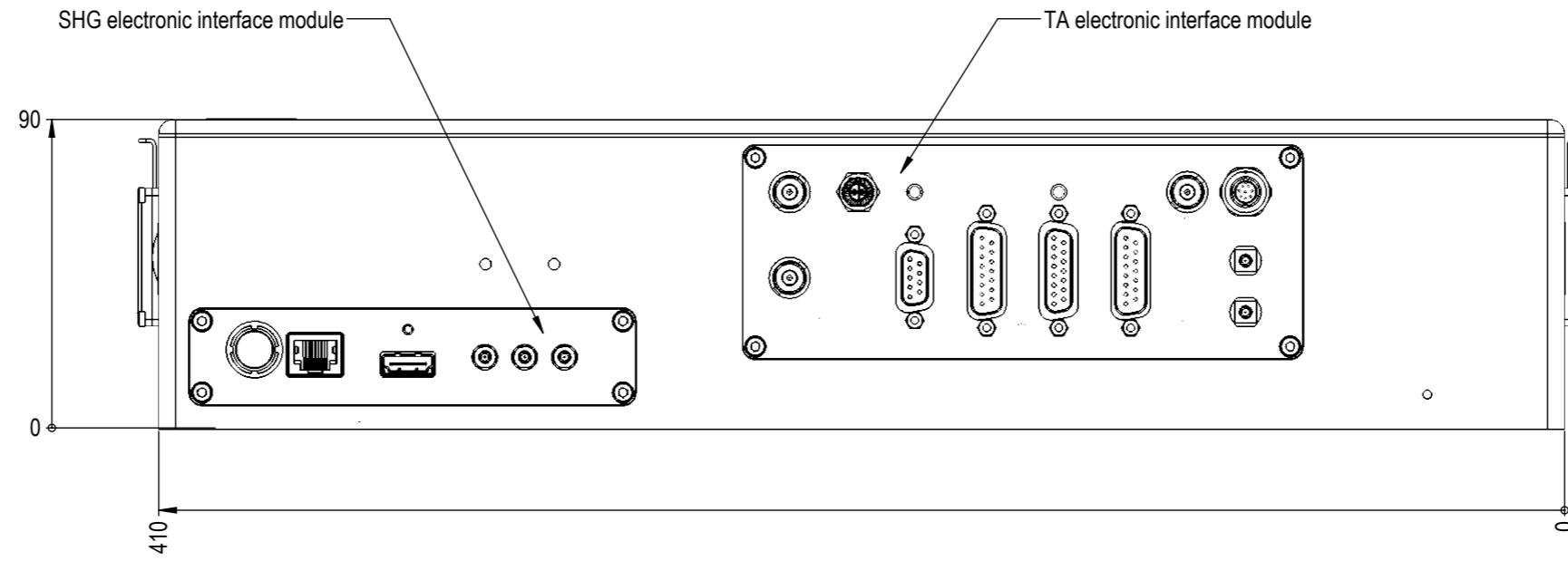

NOTE: This document is property of the company TOPTICA Photonics AG. All copyrights, trademarks, patents and other rights in connection herewith are expressly reserved to the company TOPTICA Photonics AG and no license is created hereby.



 Lochhamer Schlag 19 82166 Gräfelfing Tel.: 089-85837-0 Fax.: 089-85837-200	title		scale
	TA-SHG pro		1:2
dimensions are in mm	general tolerance	projection	date
view BACK	DIN ISO 2768 - mK		06.03.2015
			sheet
			5/7

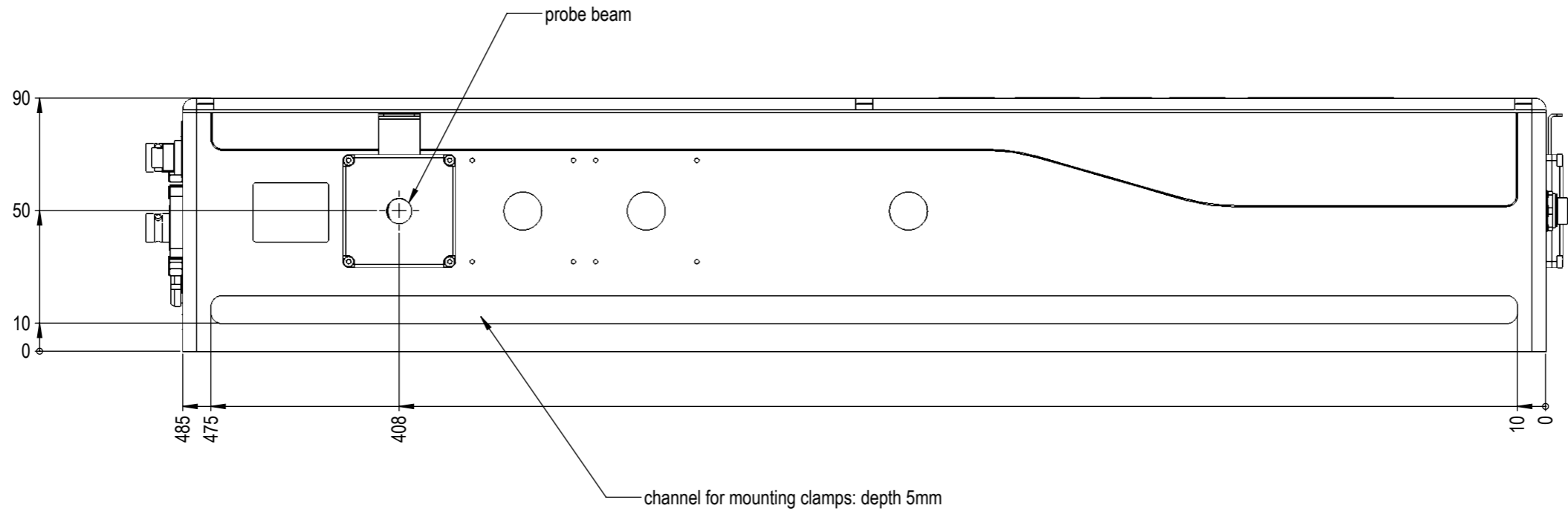

NOTE: This document is property of the company TOPTICA Photonics AG. All copyrights, trademarks, patents and other rights in connection herewith are expressly reserved to the company TOPTICA Photonics AG and no license is created hereby.

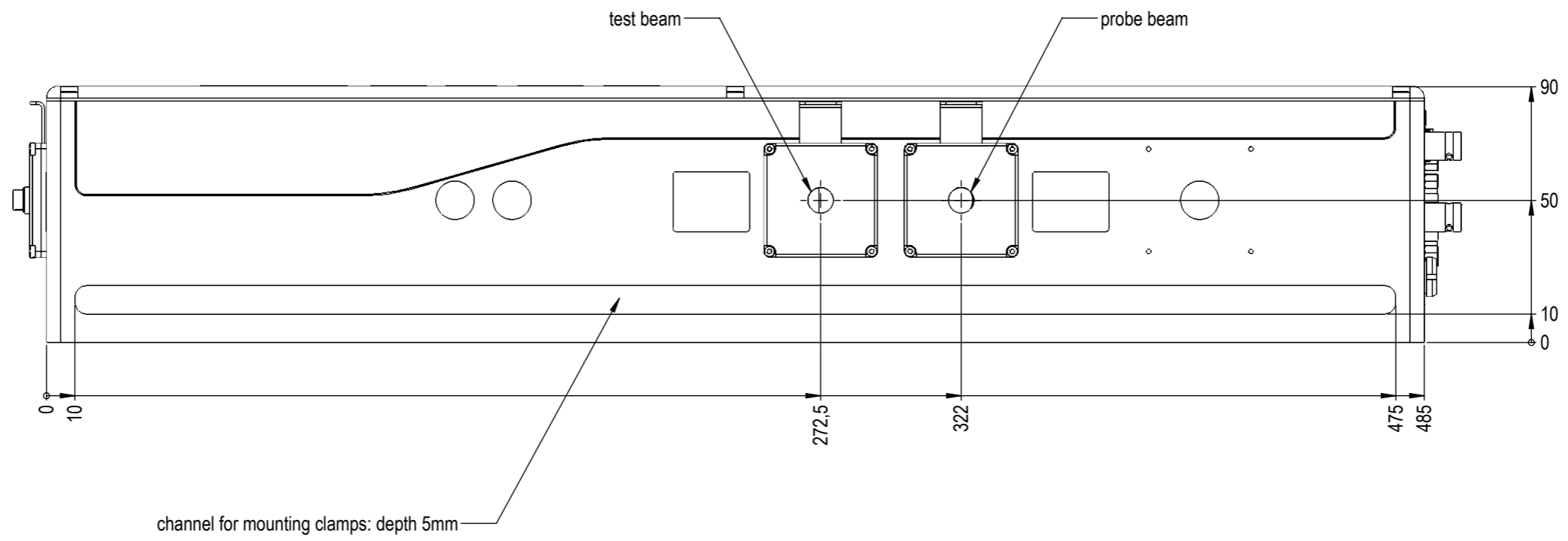

 <p>TOPTICA PHOTONICS Lochamer Schlag 19 82166 Gräfelfing Tel.: 089-85837-0 Fax.: 089-85837-200</p>	title		scale
	TA-SHG pro		1:2
dimensions are in mm	general tolerance	projection	sheet
view RIGHT	DIN ISO 2768 - mK	 06.03.2015	6/7

NOTE: This document is property of the company TOPTICA Photonics AG. All copyrights, trademarks, patents and other rights in connection herewith are expressly reserved to the company TOPTICA Photonics AG and no license is created hereby.



 Lochhamer Schlag 19 82166 Gräfelfing Tel.: 089-85837-0 Fax.: 089-85837-200	title		scale
	TA-SHG pro		1:2
dimensions are in mm	general tolerance	projection	sheet
view LEFT	DIN ISO 2768 - mK		7/7
		date	
		06.03.2015	