

		Lochamer Schlag 19 D-82166 Graefelfing www.toptica.com Phone: +49(0)189 85837-0 Fax: +49(0)189 85837-200		title: DL pro
		page: 1 von 7	scale: 7:10	DIN 6-1  dimensions are in mm
The information contained in this drawing is the sole property of TOPTICA Photonics AG. Any reproduction in part or as a whole without the written permission of TOPTICA Photonics AG is prohibited.				

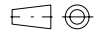

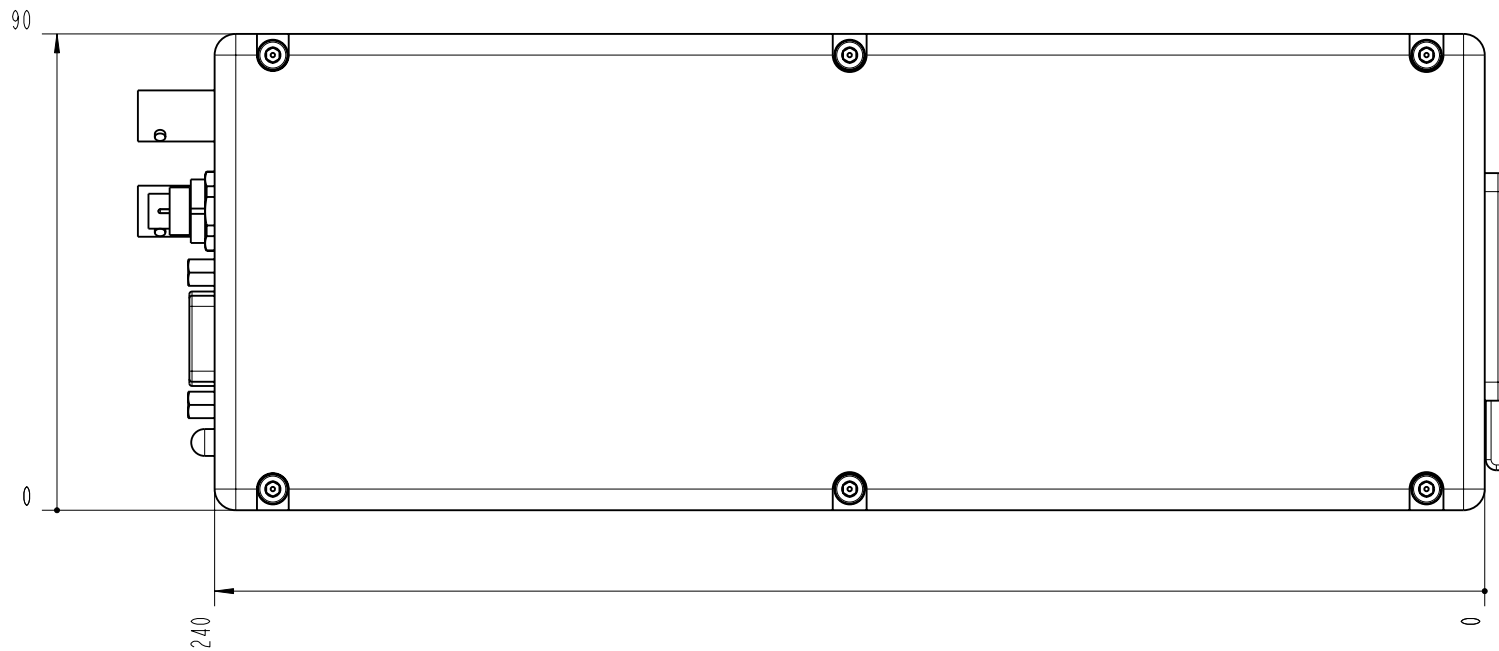

- TOP -

		Lochamer Schlag 19 D-82166 Graefelfing www.toptica.com Phone: +49(0)189 85837-0 Fax: +49(0)189 85837-200		title: DL pro	
		page: 2 von 7	scale: 7:10	DIN 6-1  dimensions are in mm	dimensions without tolerance indication: DIN ISO 2768 mH
The information contained in this drawing is the sole property of TOPTICA Photonics AG. Any reproduction in part or as a whole without the written permission of TOPTICA Photonics AG is prohibited.					

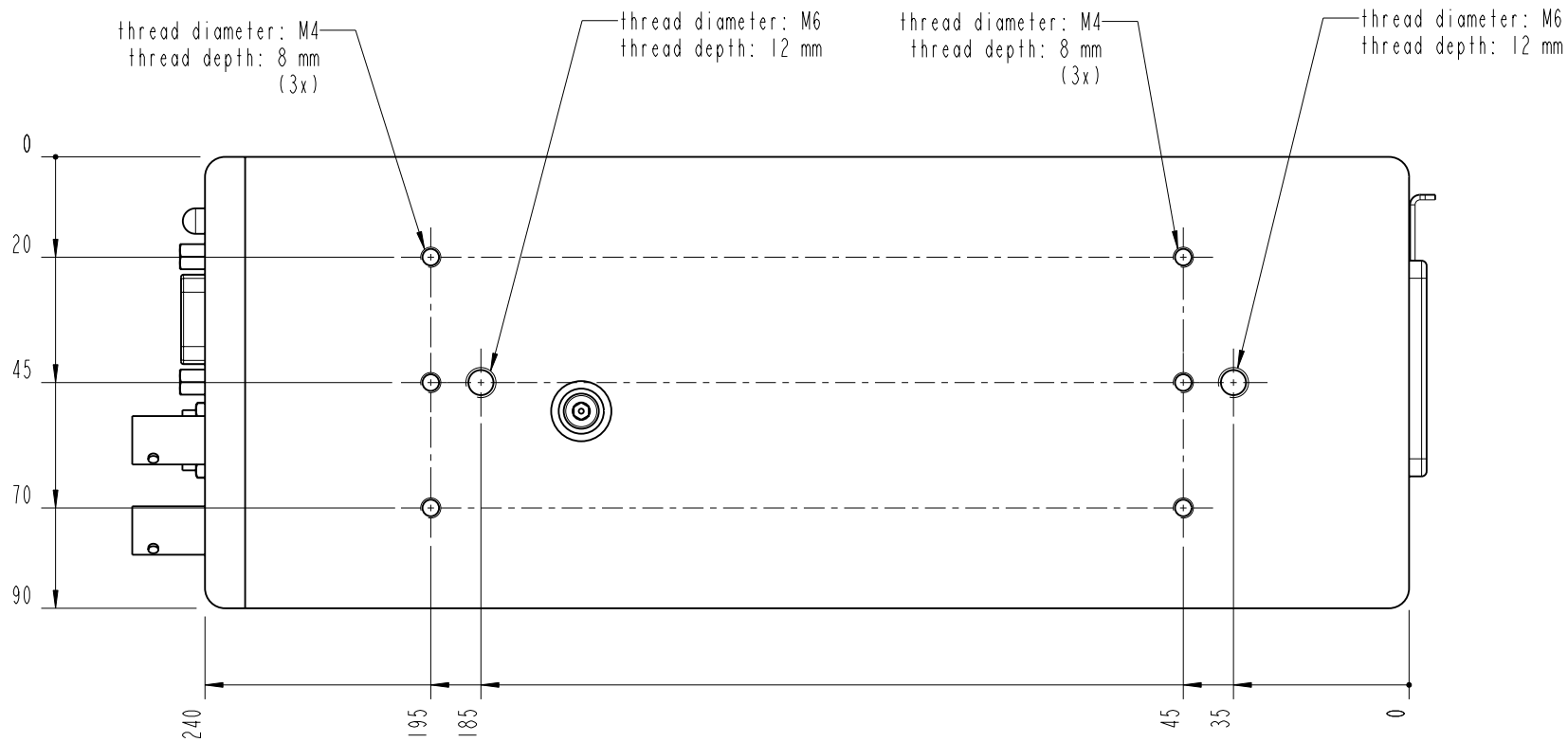

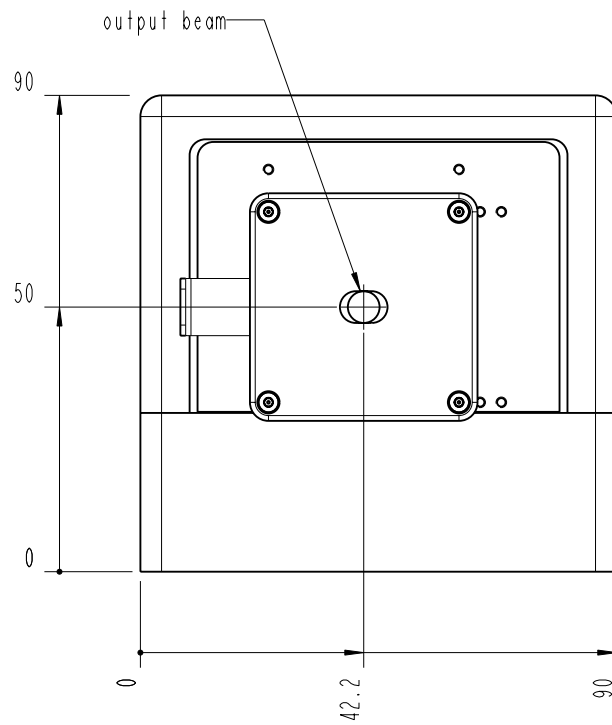

- BOTTOM -

		Lochamer Schlag 19 D-82166 Graefelfing www.toplica.com Phone: +49(0)189 85837-0 Fax: +49(0)189 85837-200		title: DL pro	
		page: 3 von 7	scale: 7:10	DIN 6-1  dimensions are in mm	dimensions without tolerance indication: DIN ISO 2768 mH
The information contained in this drawing is the sole property of TOPTICA Photonics AG. Any reproduction in part or as a whole without the written permission of TOPTICA Photonics AG is prohibited.					



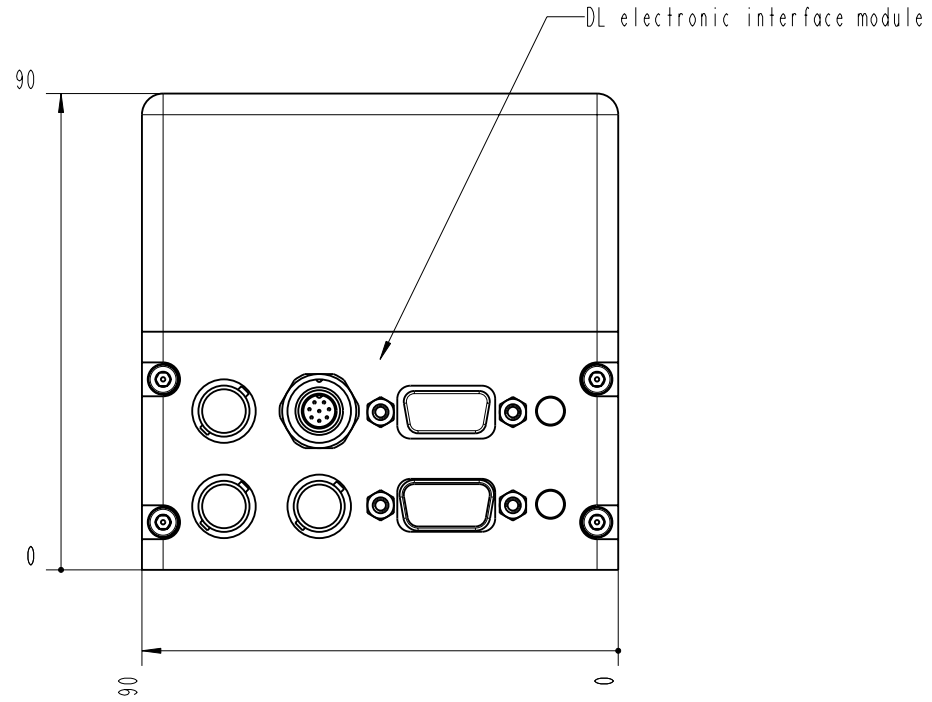

- FRONT -

		Lochamer Schlag 19 D-82166 Graefelfing www.toptica.com Phone: +49(0)189 85837-0 Fax: +49(0)189 85837-200		title: DL pro	
		page: 4 von 7	scale: 7:10	DIN 6-1  dimensions are in mm	dimensions without tolerance indication: DIN ISO 2768 mH
The information contained in this drawing is the sole property of TOPTICA Photonics AG. Any reproduction in part or as a whole without the written permission of TOPTICA Photonics AG is prohibited.					



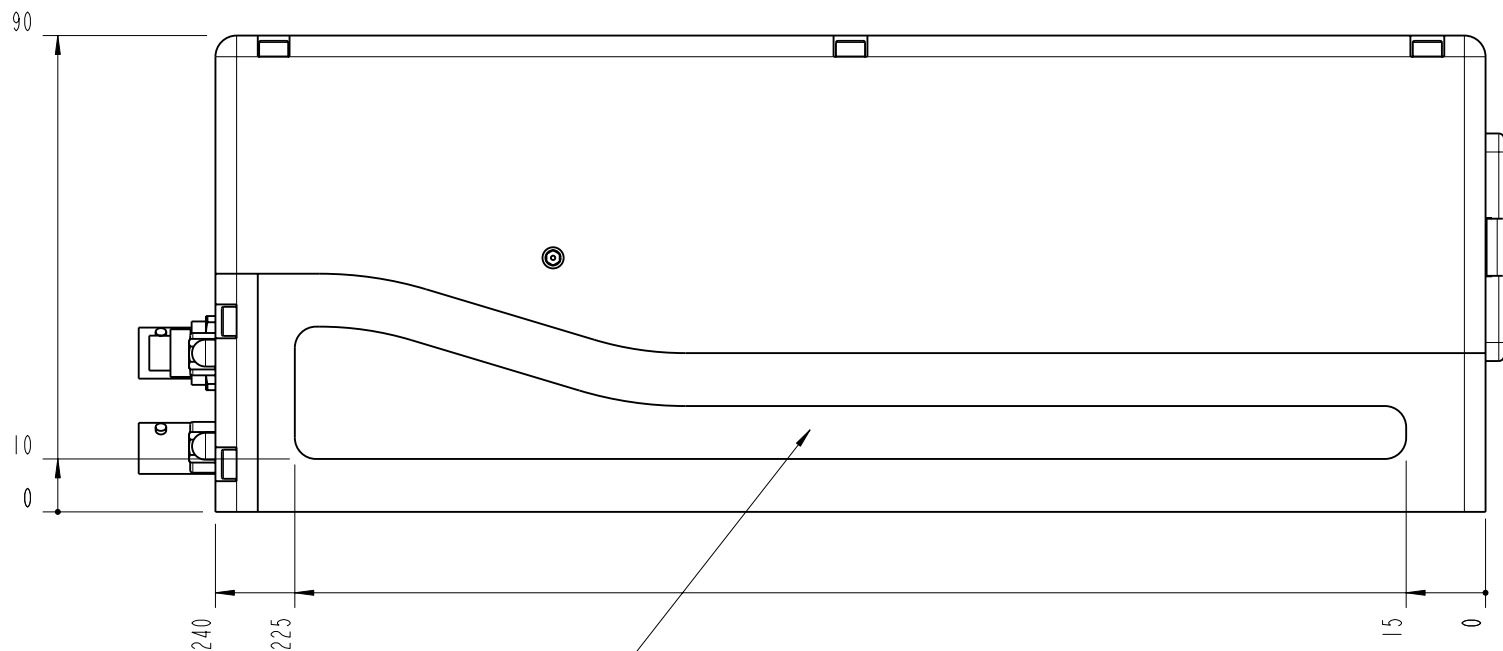

- BACK -

		Lochamer Schlag 19 D-82166 Graefelfing www.toptica.com Phone: +49(0)189 85837-0 Fax: +49(0)189 85837-200		title: DL pro
		page: 5 von 7	scale: 7:10	DIN 6-1  dimensions are in mm
The information contained in this drawing is the sole property of TOPTICA Photonics AG. Any reproduction in part or as a whole without the written permission of TOPTICA Photonics AG is prohibited.				





channel for mounting clamps: depth 5mm

- RIGHT -

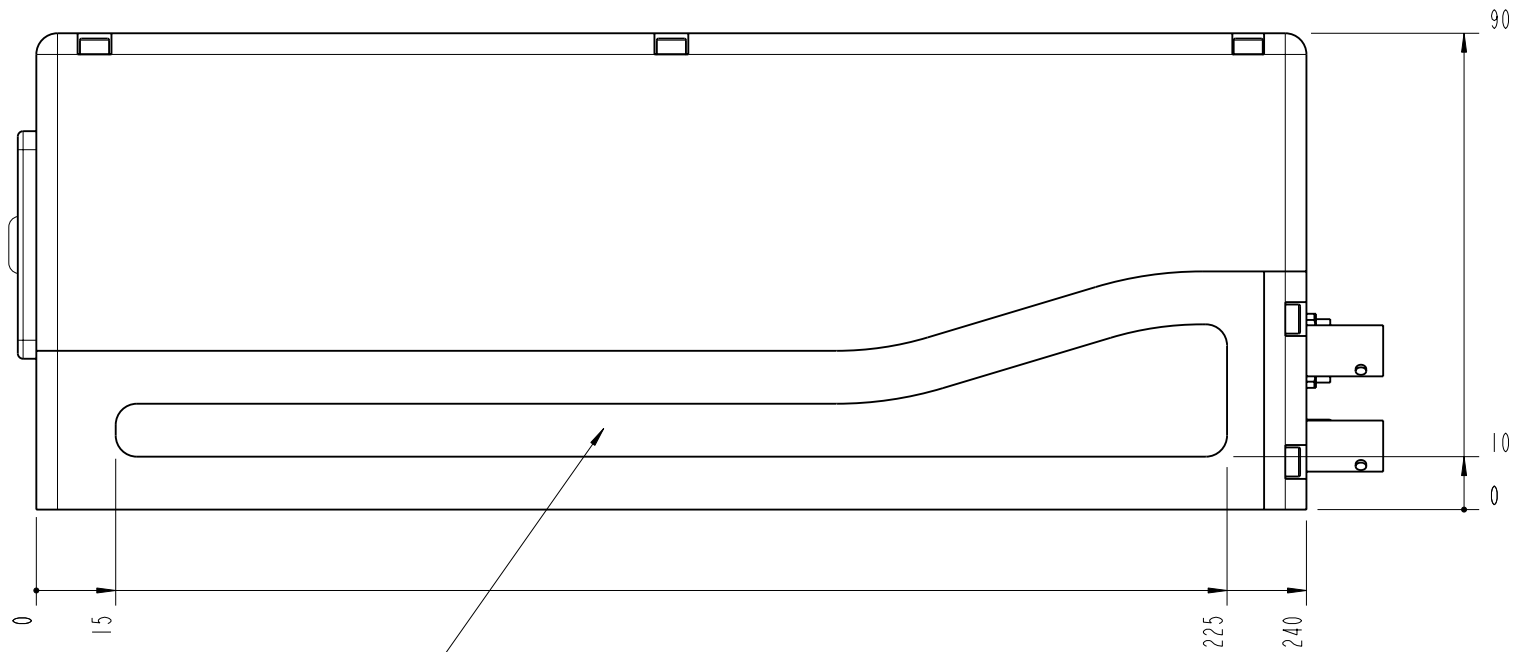
		Lochamer Schlag 19 D-82166 Graefelfing www.toplica.com Phone: +49(0)189 85837-0 Fax: +49(0)189 85837-200		title: DL pro	
		page: 6 von 7	scale: 7:10	DIN 6-1  dimensions are in mm	dimensions without tolerance indication: DIN ISO 2768 mH
The information contained in this drawing is the sole property of TOPTICA Photonics AG. Any reproduction in part or as a whole without the written permission of TOPTICA Photonics AG is prohibited.					



- LEFT -

		Lochamer Schlag 19 D-82166 Graefelfing www.toptica.com Phone: +49(0)189 85837-0 Fax: +49(0)189 85837-200	title: DL pro
page: 7 von 7	scale: 7:10	DIN 6-1  dimensions are in mm	dimensions without tolerance indication: DIN ISO 2768 mH
The information contained in this drawing is the sole property of TOPTICA Photonics AG. Any reproduction in part or as a whole without the written permission of TOPTICA Photonics AG is prohibited.			