

# iBeam smart Family

Single-Mode Diode Lasers



Raman Microscopy / Spectroscopy  
Interferometry



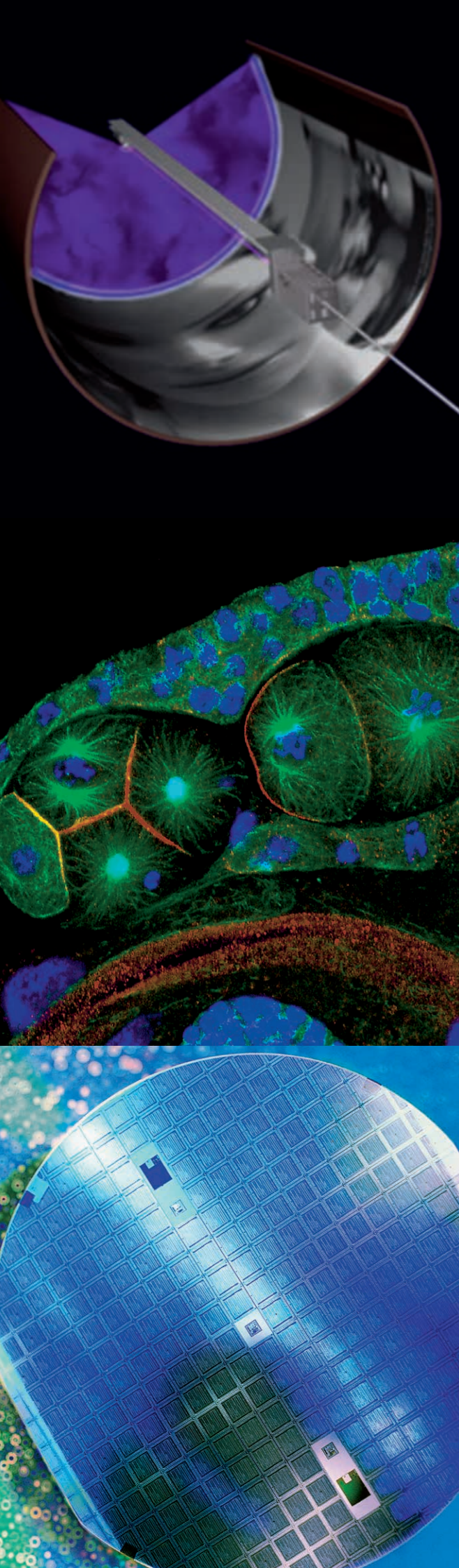

## Contents

<b>Colorful Diode Lasers</b>	3
<b>Unique Features</b>	4
<b>iBeam smart</b>	6
<b>iBeam smart PT</b>	8
<b>iBeam smart WS</b>	10
<b>Options</b>	12
<b>Applications</b>	13
<b>Technical Drawings</b>	14

# COLORFUL DIODE LASERS

## Engineered for Maximum Performance

The iBeam smart family is the ultimate choice when looking for a high-performance, ultra-reliable OEM diode laser system. Providing wavelengths from the UV to the IR the iBeam smart family serves a variety of demanding applications. The success story of these lasers is based on excellence in all aspects of a modern diode laser: High optical output power, wide wavelength coverage, low noise operation and ultra-stable beam pointing.

The iBeam smart family offers unique features that set the benchmark in the competitive field of compact laser sources. High speed complete on/off modulation (with a true zero-photon off state) from a compact single box unit widely exceeds the performance of any acousto-optical modulation technique. Integration into optical setups is easy with the Feedback Induced Noise Eraser (FINE) function of the iBeam smart series. FINE makes the lasers insensitive to optical back reflec-

tions and guarantees a low noise operation even in the case of fiber coupling. Another highlight of the iBeam smart series is the SKILL speckle reduction feature ("Speckle KILLer"), which minimizes and stabilizes the coherence length of the laser at the push of a button.

TOPTICA's pigtailed diode laser line iBeam smart PT, is the market's gold standard for long-term power stability and reliability. This is achieved with TOPTICA's proprietary fiber coupling technology COOL<sup>DC</sup> (Constant Optical Output Level – Dura-Calibrated). In addition TOPTICA's unique long-life fibers prevent fiber degradation at violet and UV wavelengths.

Using wavelength stabilized laser diodes within the iBeam smart WS, single-frequency operation is added to the series. With linewidths in the 10 MHz range and coherence lengths of several meters, the iBeam smart WS is a compact and cost-effective choice for demanding applica-

### Applications

- Microscopy
- Flow Cytometry
- DNA Sequencing
- Microarray Scanners
- Metrology
- Inspection
- Microlithography
- Computer-to-Plate Printing
- Disc Mastering
- Raman Microscopy/Spectroscopy
- Diffuse Correlation Spectroscopy (DSC)
- Interferometry

tions, e.g. Raman, interferometry or diffuse correlation spectroscopy. Please do not hesitate to contact us for customized solutions! We will be happy to modify the parameters of our lasers according to your needs.





## UNIQUE FEATURES

Powerful, High-Quality, Ultra Reliable

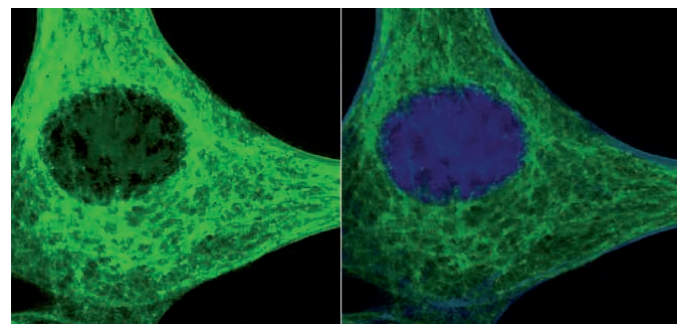

Complete on/off

The advanced electronics of the iBeam smart allow a “complete on/off” modulation up to 100 MHz. The hereby increased signal-to-noise ratio is advantageous to all measurement setups. But especially advanced microscopy techniques that require a true „zero photon“ dark state will benefit the most from this feature.

- Up to 100 MHz modulation with true “zero photon” off state
- Outstanding rise and fall times with “complete off”
- User configurable

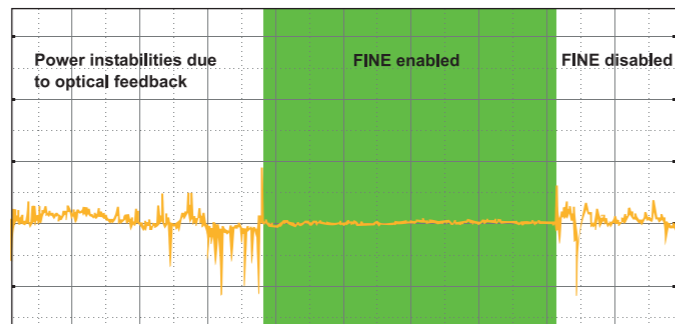

FINE

The Feedback Induced Noise Eraser FINE eliminates power instabilities and high noise levels that can be caused by back reflections into the laser. By a simple push of a button ultra-stable operation is established and the need for costly optical isolators is often eliminated.

- Elimination of feedback induced power instabilities
- Intensity noise reduction
- Purely electronic feature – no additional hardware such as optical isolators necessary
- Push of a button functionality

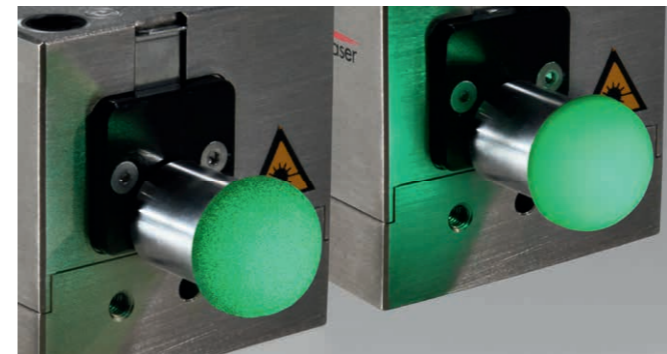

SKILL

The SKILL function acts as a purely electronic „Speckle KILLer“. By decreasing the longitudinal coherence lengths of the emitted light, the speckle generating mutual interference of wavefronts is reduced. Thus annoying speckle noise on detectors and imaging systems can be lowered to a minimum.

- Reduces speckle patterns
- Optimizes coherence length
- Purely electronic feature
- Integrated in all iBeam smart diode lasers
- Most effective at lower laser power

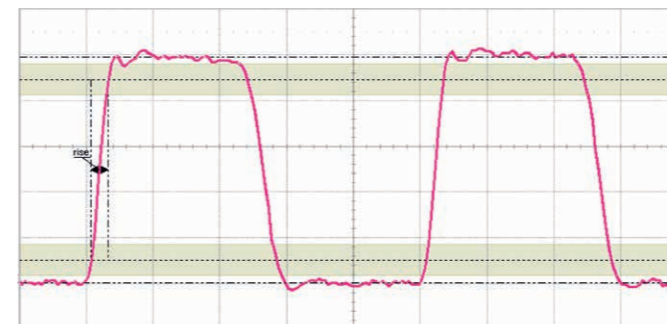

Digital Modulation

The digital modulation option adds a 250 MHz, true asynchronous TTL trigger input. The included „Autopulse“ feature enables the laser to operate on self-generated pulses up to 10 MHz.

- 250 MHz digital modulation speed
- Excellent rise and fall times (< 1.5 ns)
- Mixed-mode triggering (analog and digital modulation simultaneously)
- Multi-level triggering

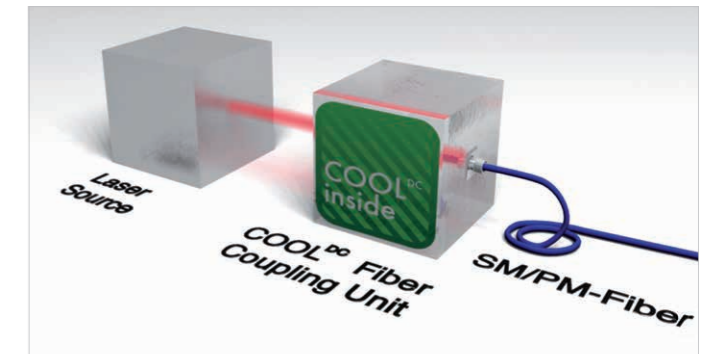

COOL<sup>DC</sup>

TOPTICA's unique COOL technology guarantees a Constant Optical Output Level for the high power, single-mode fiber-coupled laser iBeam smart PT. The special mechanical design leads to outstanding robustness against thermal and mechanical influences. The need for time-consuming single-mode fiber alignment is eliminated, making the iBeam smart PT an „out of the box – ready to use“ laser.

- Factory set to permanent fiber coupling efficiency of higher than 50 %
- Unsusceptible to thermal fluctuations
- Unsusceptible to extensive mechanical disturbances
- Drop shipment warranty

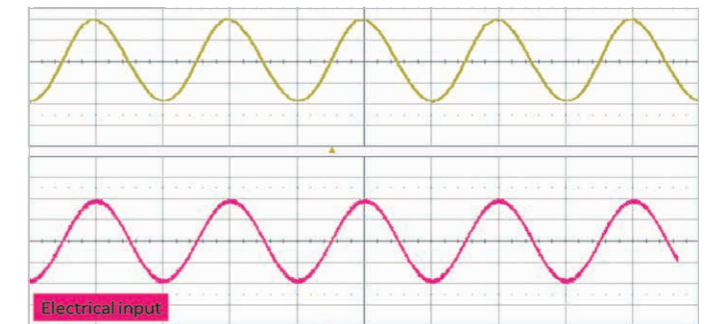

Analog Modulation

All iBeam smart models incorporate an analog modulation input, enabling modulation up to 1 MHz.

- No extra hardware (e.g. AOM/AOTF) required
- User configurable (high-/low-active)
- Mixed-mode triggering (analog and digital modulation simultaneously)

# iBeam smart

## High-Performance Diode Laser

### Key Features

- Single-mode, TEM<sub>00</sub> laser from 375 to 1060 nm
- True one box solution, no control box necessary
- Complete off (zero photon) modulation
- Ultimate long-term power and beam pointing stability
- FINE and SKILL to eliminate noise and speckle
- Analog Modulation up to 1 MHz, Digital Modulation up to 250 Mhz
- Fiber coupling with up to 90 % SM/PM fiber coupling efficiency available

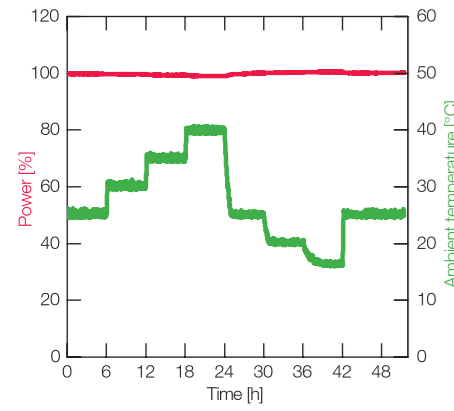
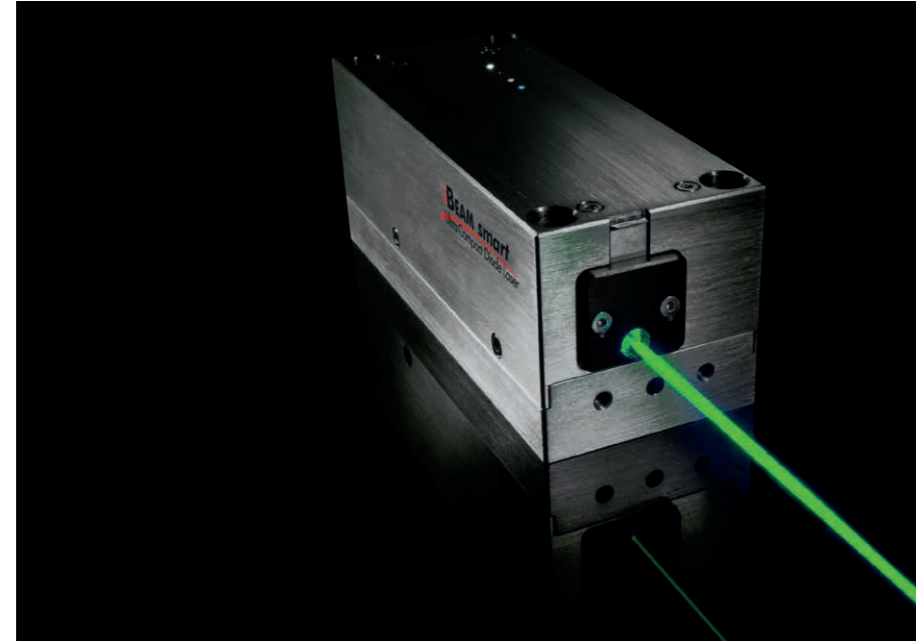

Best power stability (< 0.5 % drift over 48 h) even under changing ambient temperature

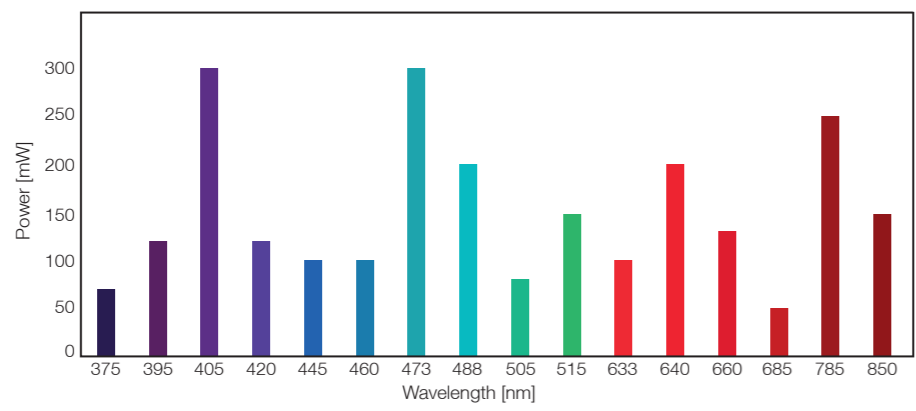

iBeam smart standard wavelengths with highest optical power.

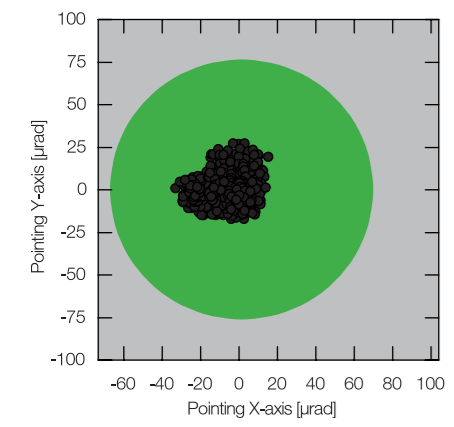

Ultimate beam pointing stability – beam stays easily within specification.

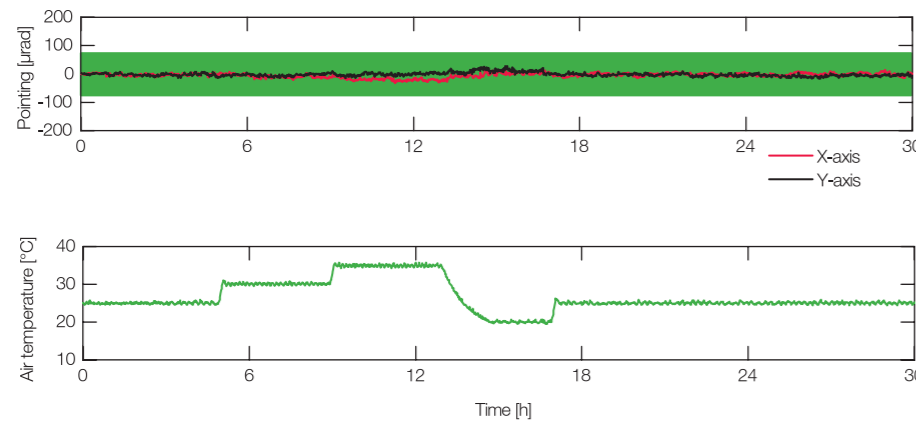

Best power stability (< 0.5 % drift over 48 h) even under changing ambient temperature.

 Class 3B Laser Product EN 60825-1:2014.  
Visible and invisible laser radiation. Avoid direct exposure to beam.  
Caution - Class 3B visible and invisible laser radiation when open.  
Avoid exposure to the beam

## Specifications

Specifications iBeam smart													
iBeam smart	375	395	405	420	445	460	473	488	505	515	633	640	647
<b>Optical Specifications</b>													
Center Wavelength Range <sup>(1)</sup> [nm]	375 ± 3	395 ± 5	405 ± 4	420 ± 5	445 ± 5	460 ± 5	473 ± 5	488 ± 4	505 ± 2	515 ± 5	633 ± 3	640 ± 5	647 ± 3
Output power [mW]	70	120	100	120	100	100	100	100	80	100	100	150	150
			150		450	450	300	200		150		200	
			300				300						
			400										
Min. fiber coupled output power [mW]	45	75	65	75	65	65	65	65	50	65	65	100	100
			100		290	290	200	130		100		130	
			200				200						
			250										
Power stability	< 0.5 % (drift over 48 h @ room temperature ± 5 °C)												
RMS Noise (10 Hz – 10 MHz) (typ.)	< 0.2 %												
Beam diameter (typ.@1/e <sup>2</sup> ) [mm]	1.2	1.2	1.2	1.2	1.3	1.1	1.3	1.2	1.1	1.1	1.0	1.0	1.2
Beam shape, ellipticity	Circular, < 10 %												
	Typ. Divergence [mrad]	< 0.6	< 0.6	< 0.6	< 0.6	< 0.7	< 0.7	< 0.7	< 0.7	< 0.8	< 0.7	< 1.0	< 1.0
M <sup>2</sup>	< 1.2												
Spatial Mode	TEM <sub>00</sub>												
Pointing stability	< 5 µrad / K												
Static alignment <sup>(2)</sup>	± 0.2 mm (xy), ± 0.5 mrad (angular)												
Polarization	Linear, Orientation: vertical (± 3°), Ratio > 50:1 (> 100:1 typ.)												
<b>Electronic Specifications</b>													
<b>Analog Modulation</b>													
Max. modulation frequency	1 MHz												
Analog modulation extinction ratio	10 <sup>0</sup> : 1												
<b>Digital Modulation (option)</b>													
Supported signal levels	TTL / TTL complete off												
Max. modulation frequency	250 MHz / 100 MHz with complete off												
Rise / fall time (10 % - 90 %)	< 1.5 ns												
Modulation extinction ratio	> 1000:1 ∞ with complete off <sup>(3)</sup>												
<b>Electronic Shutter</b>													
Rise / fall time	40 / 10 µs												
Extinction ratio	∞ (complete off) <sup>(3)</sup>												
<b>General and Environmental Specifications</b>													
Qualification	CE marked, Laser Class IIIb qualification, Level 4 ESD protection, RoHS compliant												
PC interface	RS 232, ≤ 115.200 baud												
DC input	12 V DC, 2A												
Power consumption	< 18 W (typ. < 6 W)												
Heat dissipation	< 18 W (baseplate @ 50 °C)												
Warm-up time	< 5 min												
Temperature range	15 - 40 °C (operation), -10 - 60 °C (storage)												
Relative humidity	< 90 % (non-condensing)												
Dimensions	40 x 40 x 100 mm <sup>3</sup> (H x W x D)												
Weight	< 250 g												
All specifications are valid for 100 % optical power. <sup>(1)</sup> Other wavelengths on request. <sup>(2)</sup> Static alignment tolerances are relative to reference holes in baseplate. <sup>(3)</sup> Except for 488, 505 and 515 nm. Please inquire.													

All specifications are subject to change without notice.

 Class 3B Laser Product EN 60825-1:2014.  
Visible and invisible laser radiation. Avoid direct exposure to beam.  
Caution - Class 3B visible and invisible laser radiation when open.  
Avoid exposure to the beam

## Specifications

Specifications iBeam smart															
iBeam smart	660	670	685	705	728	785	808	830	850	940	980	1064			
<b>Optical Specifications</b>															
Center Wavelength Range <sup>(1)</sup> [nm]	660 ± 3	670 ± 2	685 ± 5	705 ± 5	728 ± 5	785 ± 5	808 ± 5	830 ± 5	850 ± 5	940 ± 5	980 ± 10	1064 ± 10			
Output power [mW]	70	10	50	35	35	150	50	150	150	300	150	200			
													130	125	250
													200		
Min. fiber coupled output power [mW]	45	5	32	20	20	100	32	100	200	200	100	130			
													85	80	200
													130		
Power stability	< 0.5 % (drift over 48 h @ room temperature ± 5 °C)														
RMS Noise (10 Hz – 10 MHz) (typ.)	< 0.2 %														
Beam diameter (typ.@1/e <sup>2</sup> ) [mm]	1.2	1.2	1.2	1.2	1.2	1.4	1.2	1.2	1.0	1.2	1.2	1.2			
Beam shape, ellipticity	Circular, < 10 %														
	Typ. Divergence [mrad]	< 1.0	< 1.0	< 1.0	< 1.0	< 1.0	< 1.2	< 1.2	< 1.2	< 1.2	< 1.3	< 1.4	< 1.4		
M <sup>2</sup>	< 1.2														
Spatial Mode	TEM <sub>00</sub>														
Pointing stability	< 5 µrad / K														
Static alignment <sup>(2)</sup>	± 0.2 mm (xy), ± 0.5 mrad (angular)														
Polarization	Linear, Orientation: vertical (± 3°), Ratio > 50:1 (> 100:1 typ.)														
<b>Electronic Specifications</b>															
<b>Analog Modulation</b>															
Max. modulation frequency	1 MHz														
Analog modulation extinction ratio	10 <sup>0</sup> : 1														
<b>Digital Modulation (option)</b>															
Supported signal levels	TTL / TTL complete off														
Max. modulation frequency	250 MHz / 100 MHz with complete off														
Rise / fall time (10 % - 90 %)	< 1.5 ns														
Modulation extinction ratio	> 1000:1 ∞ with complete off <sup>(3)</sup>														
<b>Electronic Shutter</b>															
Rise / fall time	40 / 10 µs														
Extinction ratio	∞ (complete off) <sup>(3)</sup>														
<b>General and Environmental Specifications</b>															
Qualification	CE marked, Laser Class IIIb qualification, Level 4 ESD protection, RoHS compliant														
PC interface	RS 232, ≤ 115.200 baud														
DC input	12 V DC, 2A														
Power consumption	< 18 W (typ. < 6 W)														
Heat dissipation	< 18 W (baseplate @ 50 °C)														
Warm-up time	< 5 min														
Temperature range	15 - 40 °C (operation), -10 - 60 °C (storage)														
Relative humidity	< 90 % (non-condensing)														
Dimensions	40 x 40 x 100 mm <sup>3</sup> (H x W x D)														
Weight	< 250 g														
All specifications are valid for 100 % optical power. <sup>(1)</sup> Other wavelengths on request. <sup>(2)</sup> Static alignment tolerances are relative to reference holes in baseplate. <sup>(3)</sup> Except for 488, 505 and 515 nm. Please inquire.															

All specifications are subject to change without notice.



# iBeam smart PT

## Pigtailed High-Performance Diode Laser



Class 3B Laser Product EN 60825-1:2014.  
Visible and invisible laser radiation. Avoid direct exposure to beam.  
Caution - Class 3B visible and invisible laser radiation when open.  
Avoid exposure to the beam

## Specifications

### Key Features

- Pigtailed diode laser from 405 to 785 nm
- COOL<sup>DC</sup>: ultra stable permanent fiber coupling
- FINE: Eliminates noise from optical feedback
- Complete off (zero photon) modulation
- SKILL: Reduces speckle in your application
- Analog Modulation up to 1 MHz, Digital Modulation up to 250 Mhz
- FC/AFC fiber connector (others on request)

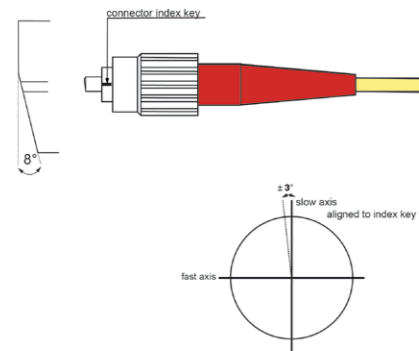

Standard fiber output connector FC/AFC and polarization orientation at fiber connector

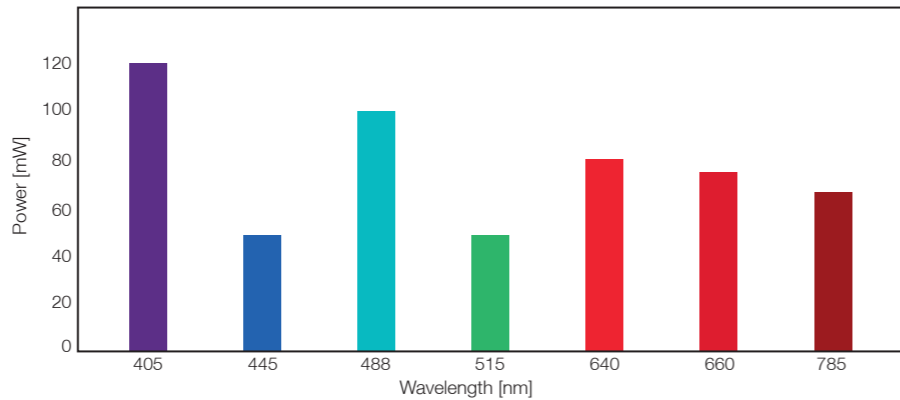

iBeam smart PT standard wavelengths with highest optical power

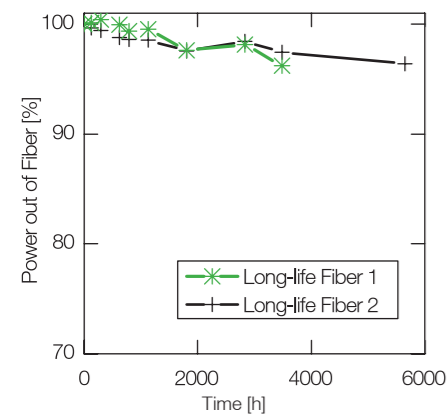

TOPTICA long-life fiber. Minimum degradation at UV/violet wavelengths

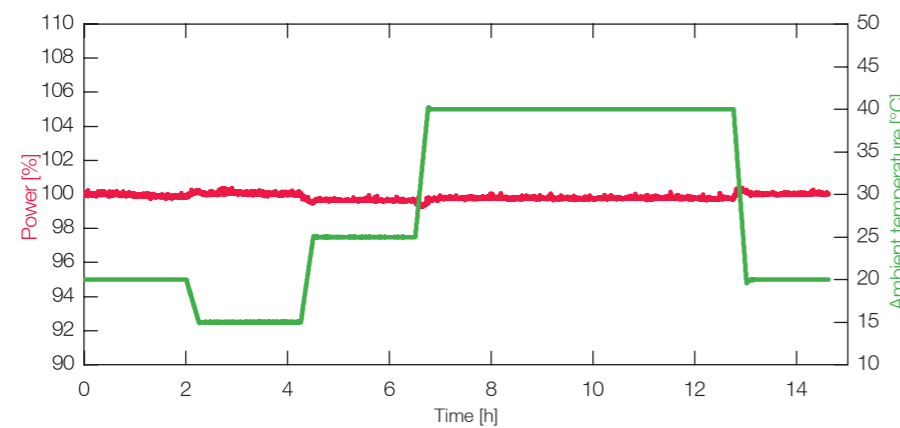

Fiber coupled power stability (< 0.5 % drift over 24 h) even under changing ambient temperature

Specifications iBeam smart PT											
iBeam smart PT	375	405	445	488	515	633	640	660	728	785	850
<b>Optical Specifications</b>											
Center Wavelength Range (nm)	375 ± 2	405 ± 4	445 ± 5	488 ± 4	515 ± 5	633 ± 5	640 ± 5	660 ± 5	728 ± 5	785 ± 5	850 ± 10
Fiber coupled output power (mW)	30	60 120	50 120	50 100	75	50	80 100	75 100	20	75	75
Power Stability	≤ 2 % (drift over 48 h @ room temperature ± 2 °C)										
RMS Noise (10 Hz – 10 MHz) (typ.)	≤ 0.4 %										
Beam shape, ellipticity	circular, < 10%										
M <sup>2</sup>	< 1.1										
Polarization	Linear, slow axis aligned to index key with orientation tolerance of ± 3°, Ratio > 50:1 (> 100:1 typ.)										
<b>Fiber Specifications</b>											
Fiber output connector	FC / AFC (8° angled) standard, others like FC / PC, FC / APC or SC on request										
Fiber cable length (typ.)	2 m										
Fiber cable type	3 mm Kevlar reinforced PVC										
Fiber minimum bend radius	40 mm										
Fiber type	single-mode, polarization maintaining										
Fiber numerical aperture (5 %) (typ.)	0.075	0.075	0.07	0.07	0.1	0.11	0.11	0.11	0.11	0.12	0.12
Mode field diameter (μm) (typ.)	2.8	3.0	3.0	3.5	4.2	4.2	4.2	4.2	4.5	4.5	5.0
<b>Electronic Specifications</b>											
<b>Analog Modulation</b>											
Maximum analog modulation frequency	1 MHz										
Analog modulation extinction ratio	10 <sup>6</sup>										
<b>Digital Modulation (option)</b>											
Supported digital signal levels	TTL / TTL complete off										
Maximum digital modulation frequency	250 MHz / 100 MHz with complete off										
Rise / fall time	< 1.5 ns										
Digital modulation extinction ratio	> 1000 : 1 / ∞ with complete off <sup>(2)</sup>										
<b>Electronic Shutter</b>											
Rise / fall time	40 / 10 μs										
Extinction ratio	∞ (complete off) <sup>(2)</sup>										
<b>General and Environmental Specifications</b>											
Qualification	CE marked, Class IIIb qualification, Level 4 ESD protection, RoHS compliant										
PC interface	RS 232, ≤ 115.200 baud										
DC input requirements	12 V DC, < 2 A										
Power consumption	< 18 W (typ. < 6 W)										
Heat dissipation	< 12 W (baseplate @ 50 °C)										
Warm-up time	< 5 min										
Temperature Range	15 – 40 ° C (operation) , -10 – 60 ° C (storage)										
Relative Humidity	< 90 % (non-condensing)										
Dimensions laser head	40 x 40 x 145 mm <sup>3</sup> (H x W x D)										
Dimensions laser head with fiber minimum bend radius	40 x 40 x 195 mm <sup>3</sup> (H x W x D)										
Weight laser head	< 360 g										

All specifications are valid for 100 % optical power.

<sup>(1)</sup> Other wavelengths on request (see also iBeam smart wavelength range). <sup>(2)</sup> Except for 488 and 515 nm. Please inquire.

All specifications are subject to change without notice.

# iBeam smart WS

## Wavelength-Stabilized Diode Laser



Class 3B Laser Product EN 60825-1:2014.  
Visible and invisible laser radiation. Avoid direct exposure to beam.  
Caution - Class 3B visible and invisible laser radiation when open.  
Avoid exposure to the beam

# Specifications

### Key Features

- Standard wavelengths: 633 nm, 638 nm, 685 nm and 785 nm
- High power diode laser (up to 120 mW)
- Narrow linewidth (typ. 10 MHz)
- Fully computer controlled
- Perfect choice for Raman applications
- Ultra compact design 100 x 40 x 40 mm<sup>3</sup>

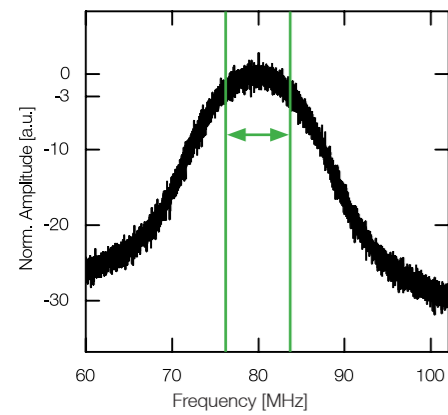
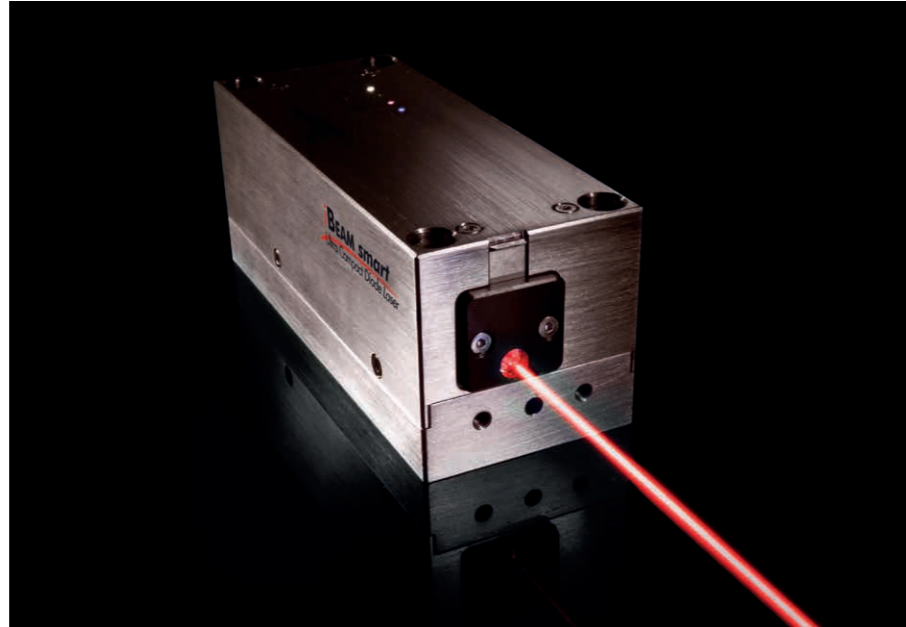

Typical linewidth < 10 MHz

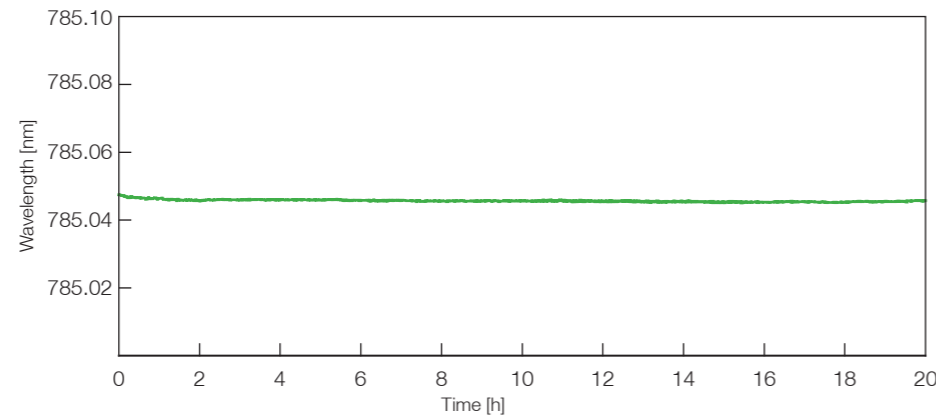

Ultimate wavelength stability, no mode-hopping

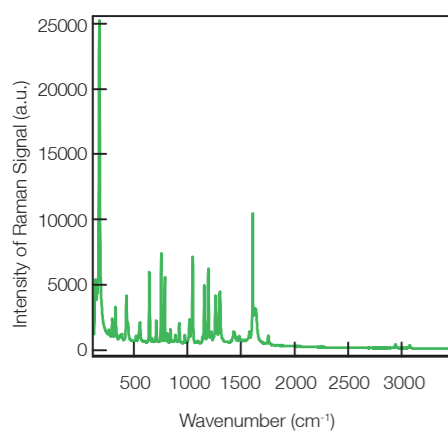

iBeam smart WS – best suited for Raman applications

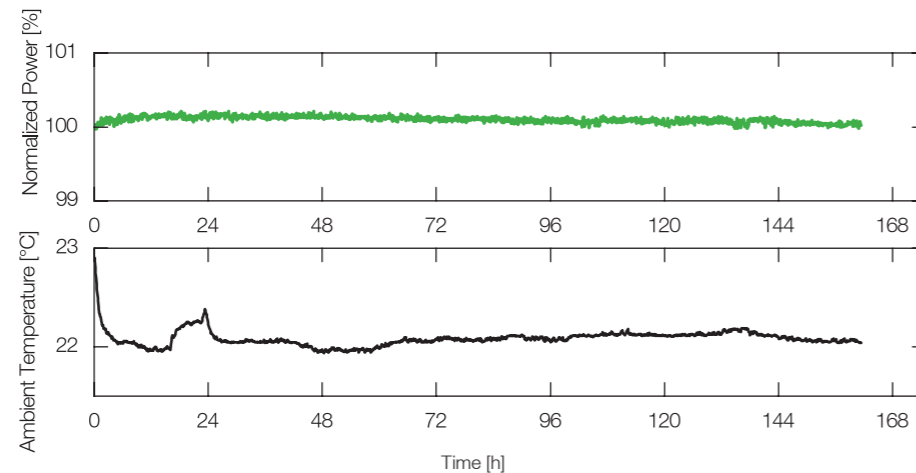

Excellent power stability













Specifications iBeam smart WS												
iBeam smart WS	633	638	660	685	785	808	828	852				
<b>Optical Specifications</b>												
Center wavelength range (nm)	633 ± 1	638 ± 1	660 ± 1	685 ± 1	785 ± 1	808 ± 1	828 ± 1	852 ± 1				
Wavelength stability	< 15 pm											
Spectral linewidth	< 25 MHz											
ASE suppression (typ.)	25 dB											
Polarization	Linear, Orientation tolerance ± 3°, Ratio (typ.) > 50:1											
Optical output power (mW)	70	30	120	35	40	120	250	100	350	70	80 / 250	250
Power stability	≤ 0.5 % (drift over 48 h @ room temperature ± 5 °C)						≤ 2 % (drift over 48 h @ room temperature ± 5 °C)					
Beam shape	elliptical	circular	elliptical	circular	circular	circular	elliptical	circular	elliptical	circular	circular	elliptical
Beam size (typ. @1/e2) (mm)	0.6 x 0,9 <sup>(2)</sup>	1.4 x 01,4 <sup>(2)</sup>	0.6 x 0,9 <sup>(2)</sup>	1.6 x 1.6	1.6 x 1.6	1.2 x 1.2	0.6 x 2,2 <sup>(2)</sup>	1.0 x 1.0	0.7 x 2,2 <sup>(2)</sup>	1.0 x 1.0	1.1 x 1.1	0.7 x 1,7 <sup>(2)</sup>
Ellipticity	30% <sup>(3)</sup>	< 10 %	30% <sup>(3)</sup>	< 10 %	< 10 %	< 10 %	30% <sup>(3)</sup>	< 10 %	30% <sup>(3)</sup>	< 10 %	< 10 %	30% <sup>(3)</sup>
Divergence (typ.)	< 2	< 1	< 2	< 1	< 1	< 1	< 2	< 1.2	< 2	< 1.2	< 1.2	< 2
M <sup>2</sup>	≤ 1.7	≤ 1.5	≤ 1.7	≤ 1.5	≤ 1.5	≤ 1.5	≤ 1.7	≤ 1.5	≤ 1.7	≤ 1.5	≤ 1.5	≤ 1.7
M <sup>2</sup> (typ.)	< 1.5	< 1.3	< 1.5	< 1.3	< 1.3	< 1.3	< 1.5	< 1.3	< 1.5	< 1.3	< 1.3	< 1.5
Pointing stability (μrad/K)	< 10	< 10	< 10	< 10	< 10	< 10	< 10	< 10	< 10	< 10	< 10	< 10
Static alignment <sup>(4,5)</sup> x,y (mm)	± 0.4	± 0.2	± 0.4	± 0.2	± 0.2	± 0.2	± 0.4	± 0.2	± 0.4	± 0.2	± 0.2	± 0.4
Static alignment angular <sup>(4)</sup> (mrad)	± 1	± 0.5	± 1	± 0.5	± 0.5	± 0.5	± 1	± 0.5	± 1	± 0.5	± 0.5	± 1
<b>General and Environmental Specifications:</b>												
Qualification	CE marked, Laser Class IIIb qualification, Level 4 ESD protection, RoHS compliant											
PC interface	RS 232, ≤ 115.200 baud											
DC Input	12 V DC, 2 A											
Power Consumption	< 18 W (typ. < 6 W)											
Heat dissipation	< 18 W (baseplate @ 50 °C)											
Warm-up time	< 5 min											
Temperature Range	15 – 40 ° C (operation) , -10 – 60 ° C (storage)											
Relative Humidity	< 90 % (non-condensing)											
Dimensions laser head	40 x 40 x 100 mm <sup>3</sup> (H x W x D)											
Weight	< 250 g											
All specifications are valid for 100 % optical power. <sup>(1)</sup> Circularisation requires additional external beam shaping. <sup>(2)</sup> Beam size at 50 cm behind laser aperture. <sup>(3)</sup> Far field, > 150 cm. <sup>(4)</sup> Static alignment tolerances are relative to reference holes in base plate. <sup>(5)</sup> Central beam aperture, different to drawing of standard iBeam smart.												

All specifications are subject to change without notice.

Additional wavelengths like 405, 640, 658, 690, 780, 808, 850 nm and more available on request.

Option	Description	iBeam smart	iBeam smart PT	iBeam smart WS
	<b>iBeam smart Pulse Option</b> The pulse option enables the user to apply asynchronous, digital modulation signals to the iBeam smart. With optical rise and fall times in the 1 ns range, bandwidths up to 250 MHz can be achieved. The pulse option also provides the „Autopulse“ feature. Frequencies up to 10 MHz can be programmed to the iBeam smart, making an external signal generator dispensable.	✓	✓	✓*
	<b>Wavelength Selection</b> Demanding applications often need very specific wavelengths, e.g. to perfectly match absorption lines or for consistent results due to high system-to-system repeatability. For such cases TOPTICA offers wavelength selection better than ±1 nm inside the available standard wavelength range.	✓	✓	✓
	<b>SmartDock</b> Highly efficient (> 60 % guaranteed, typical > 75 %) fiber-coupling is possible with this add-on fiber-coupler for the iBeam smart. TOPTICA's patented design allows straight forward alignment, combined with ultra-stable long-term performance.	✓		✓
	<b>Clean-Up Filter</b> Laser clean-up filters provide high transmission (> 90 %) of designated wavelengths and eliminate unwanted spontaneous emission when spectral purity is critical.	✓	✓	
	<b>External Control Box</b> The CDRH compliant external controller helps scientific customers to easily integrate the laser into their setup. It provides the user with a key switch and access to all important control lines.	✓	✓	✓
	<b>FiberOut</b> This fiber output collimator with adjustable collimation guarantees excellent beam quality after the fiber. The customer can select from different lenses in order to achieve the beam diameter best suited for his application.	✓	✓	✓
	<b>Optical Isolator</b> The iBeam smart can be equipped with an external optical isolator. This option is recommended for the iBeam smart WS in order to guarantee stable single-frequency operation.	✓		✓

\* Some laser characteristics might be influenced (e.g. wavelength stability).

Application	TEM <sub>00</sub>	Power Stability	Pointing Stability	Complete Off	Fast Digital Modulation	Noise < 0.2 %	Wavelength Selection	SM/PM Fiber	FINE/SKILL	Narrow Linewidth	Common Wavelength(s)	iBeam smart	iBeam smart PT	iBeam smart WS
 <b>Microscopy</b>	✓	✓	✓	✓				✓	✓		375 nm .. 640 nm	✓	✓	
 <b>Flow Cytometry</b>	✓	✓	✓		✓	✓			✓		375 nm .. 640 nm	✓	✓	
 <b>DNA Sequencing</b>	✓	✓	✓		✓	✓					375 nm .. 660 nm	✓	✓	
 <b>HTS/HCS</b>	✓	✓	✓			✓			✓		375 nm .. 640 nm	✓	✓	
 <b>Raman Microscopy/Spectroscopy</b>	✓	✓	✓				✓	✓		✓	785 nm			✓
 <b>Diffuse Correlation Spectroscopy</b>	✓	✓	✓					✓		✓	785, 850 nm			✓
 <b>Semicon Inspection</b>	✓	✓	✓		✓	✓	✓	✓	✓		405 nm .. 785 nm	✓	✓	
 <b>Metrology/Ellipsometry</b>	✓	✓	✓			✓	✓	✓	✓		375 nm .. 785 nm	✓	✓	
 <b>Interferometry</b>	✓	✓	✓			✓	✓			✓	633 nm			✓
 <b>Microlithography</b>	✓	✓	✓		✓						375, 405, 445 nm	✓	✓	
 <b>Computer-to-Plate (CTP) Printing</b>	✓	✓	✓	✓	✓	✓					405 nm	✓	✓	
 <b>Optical Data Storage</b>	✓	✓	✓	✓	✓	✓			✓		405 nm	✓	✓	

# Technical Drawings

## iBeam smart / iBeam smart WS

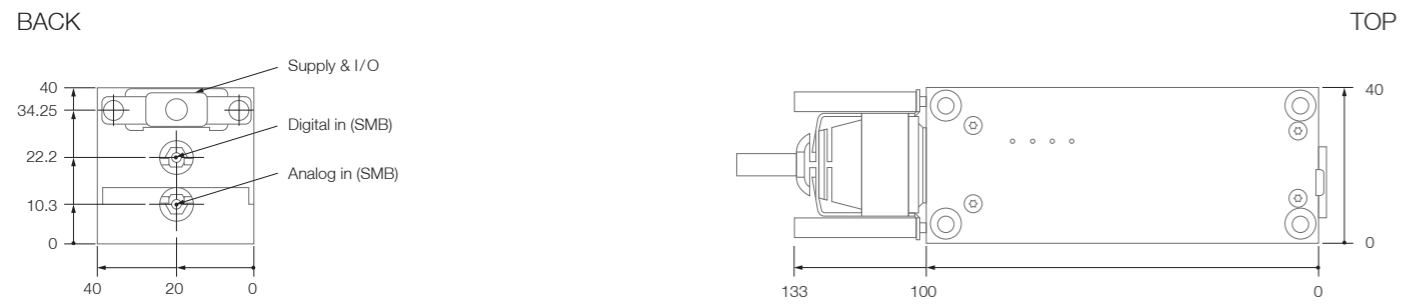
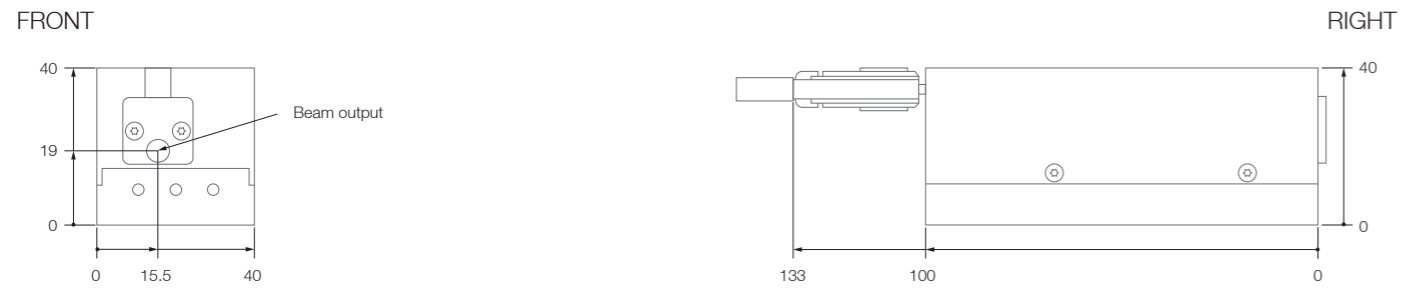

## iBeam smart with SmartDock

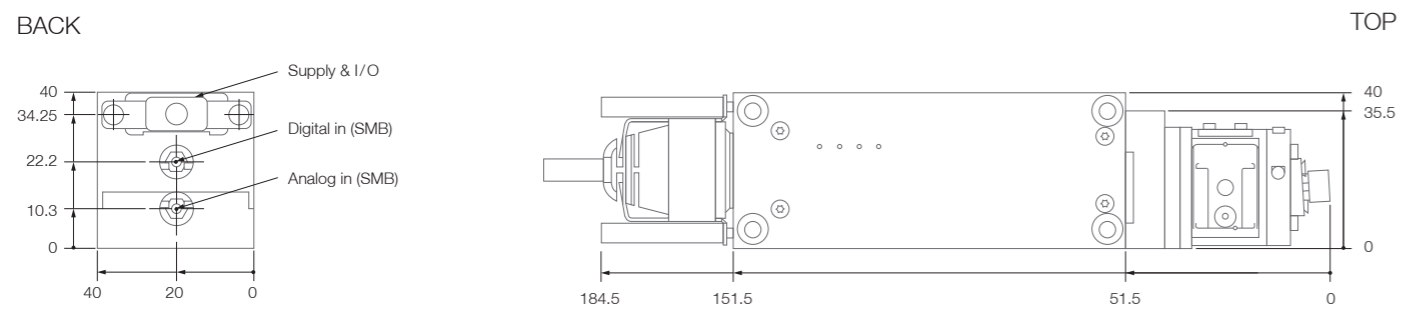
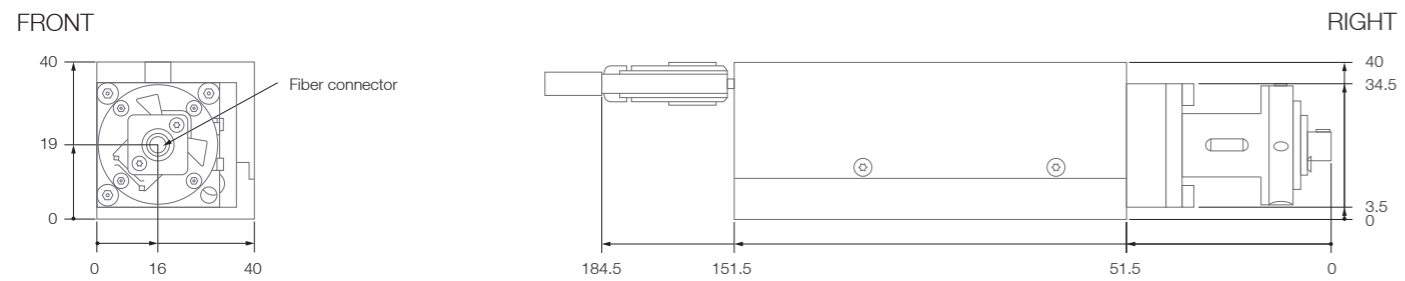

## iBeam smart with isolator

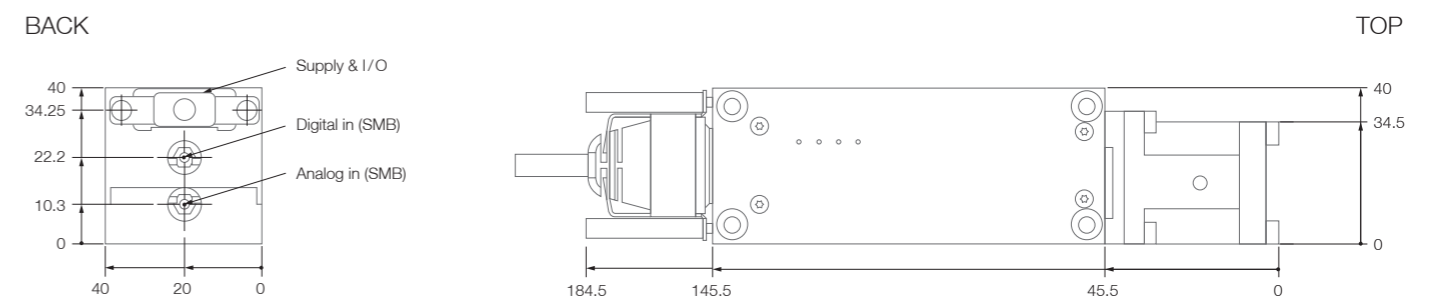
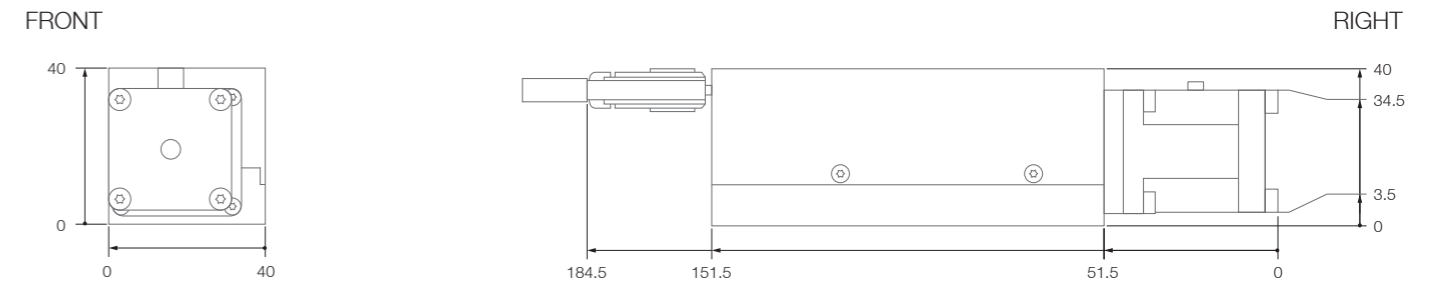

## iBeam smart PT

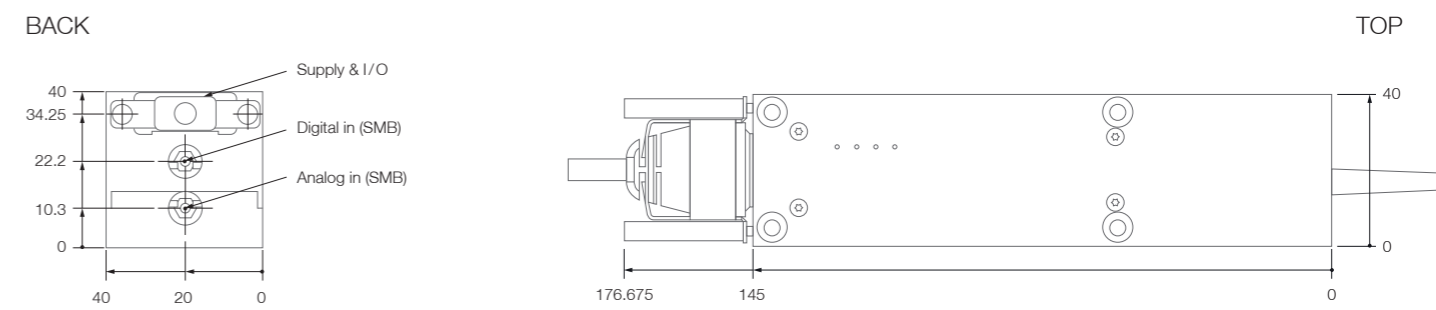
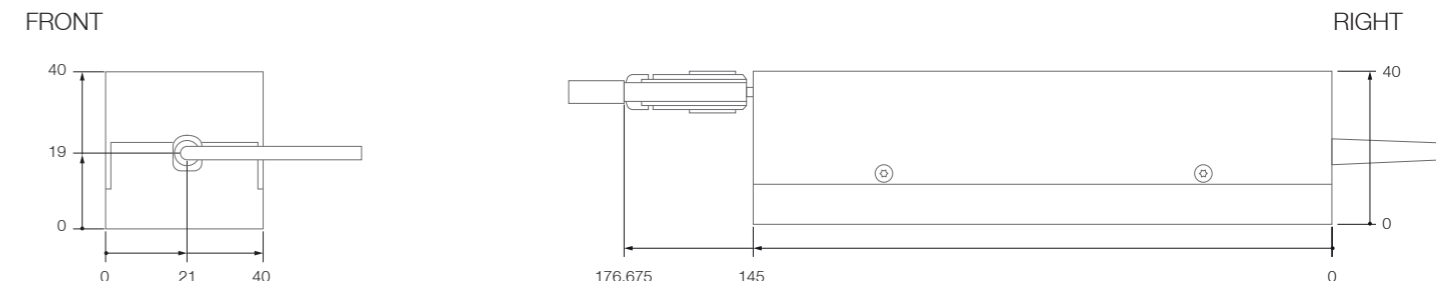

All dimensions given in mm.  
Detailed technical drawings are available on our website.





# TOPTICA Worldwide

## Australia & New Zealand

### Lastek Pty. Ltd.

Thebarton Campus  
10 Reid Street  
5031 Thebarton, SA, Australia  
Phone: +61 8 8443 8668  
Fax: +61 8 8443 8427  
sales@lastek.com.au  
www.lastek.com.au

## China

### Universal Technology Co. Ltd.

A1505 NanXinCang Business Tower  
No. 22 DongSiShiTiao  
DongCheng District  
Beijing, 100037, P.R. China  
Phone: +86 10 516 908 88-601  
Fax: +86 10 516 901 00  
oe@universaltechco.cn  
www.unjiabo.com

## France

### Opton Laser International

Parc Club d'Orsay Université  
29, rue Jean Rostand  
F-91893 Orsay Cedex, France  
Phone: +33 1 6941 0405  
Fax: +33 1 6941 3290  
ventes@optonlaser.com  
www.optonlaser.com

## India

### Simco Global Technology & Systems Ltd.

Simco House (Head Office)  
14 Bhawani Kunj  
Behind Sector D-II Vasant Kunj  
110070 New Delhi, India  
Phone: +91 99 1020 7575  
Fax: +91 11 2612 4461  
simco.del@simcogroup.in  
www.simco-groups.com

## Israel

### Lahat Technologies Ltd.

17 Atir Yeda St.  
Kfar Saba 446413, Israel  
Phone: +972 9 76 46 200  
Fax: +972 9 76 46 204  
sales@lahat.co.il  
www.lahat.co.il

## Japan

### TOPTICA PHOTONICS, K.K.

2-9-5, Miyanishi-cho, Fuchu-shi, Tokyo, 183-0022,  
Japan  
Phone: +81 42 306 9906  
Fax: +81 42 306 9907  
sales@toptica.com  
www.toptica.com

## Korea

### JINSUNG LASER

7F, E-Dong, Leaders Town  
#310, ManNyeon-Dong, Seo-Gu  
Daejeon, 302-834, South Korea  
Phone: +82 42 823 5300  
Fax: +82 42 823 7447  
sales@jinsunglaser.com  
www.jinsunglaser.com

## Russia

### EuroLase Ltd.

Profsoyuznaya 93-A  
Office 404  
117997 Moscow, Russia  
Phone: +7 495 3363044  
Fax: +7 495 3363044  
eurolase@eurolase.ru  
www.eurolase.ru

## Singapore, Malaysia & Thailand

### Precision Technologies Pte Ltd

211 Henderson Road # 13-02  
Henderson Industrial Park  
Singapore 159552  
Phone: +65 6273 4573  
Fax: +65 6273 8898  
precision@pretech.com.sg  
www.pretech.com.sg

## Spain

### Delta Optics

Edificio CTM O-227  
Orta Villaverde-Vallecas, Km 3,500  
28053 Madrid, Spain  
Phone: +34 911 130 824  
Fax: +34 910 113 757  
info@deltaoptics.es  
www.deltaoptics.es

## Taiwan

### Luxton Inc.

F4, No. 2, Technology Road V  
Hsinchu Science Park  
Hsinchu 30078, Taiwan  
Phone: +886 3 666 2097  
Fax: +886 3 666 2124  
service@luxton.com.tw  
www.luxton.com.tw

## United Kingdom & Ireland

### TOPTICA Photonics UK

Unit SU4B, Lansbury Estate  
102 Lower Guildford Road  
Knaphill, Woking  
Surrey, GU21 2EP, Great Britain  
Phone: +44 1483 662 660  
Fax: +44 1483 799 076  
enquiries@toptica-uk.com  
www.toptica.com

## USA, Canada & Mexico

### TOPTICA Photonics, Inc.

5847 County Road 41  
Farmington, NY 14425, U.S.A.  
Phone: +1 585 657 6663  
Fax: +1 877 277 9897  
sales@toptica-usa.com  
www.toptica.com

## Every other country not listed

### TOPTICA Photonics AG

Lochhamer Schlag 19  
D-82166 Graefelfing / Munich, Germany  
Phone: +49 89 85837 0  
Fax: +49 89 85837 200  
sales@toptica.com  
www.toptica.com



**TOPTICA Photonics AG**  
Lochhamer Schlag 19  
D-82166 Graefelfing / Munich  
Germany  
Phone: +49 89 85837-0  
Fax: +49 89 85837-200  
sales@toptica.com  
www.toptica.com

**TOPTICA Photonics, Inc.**  
1286 Blossom Drive  
Victor/Rochester, NY 14564  
U.S.A.  
Phone: +1 585 657 6663  
Fax: +1 877 277 9897  
sales@toptica.com  
www.toptica.com

**TOPTICA Photonics, K.K.**  
2-9-5, Miyanishi-cho, Fuchu-shi, Tokyo,  
183-0022,  
Japan  
Phone: +81 42 306 9906  
Fax: +81 42 306 9907  
sales@toptica.com  
www.toptica.co.jp